

Instruction Manual

MP-M3/M5/M20

(This manual is also applicable to ST/A/D
and other expansion series)

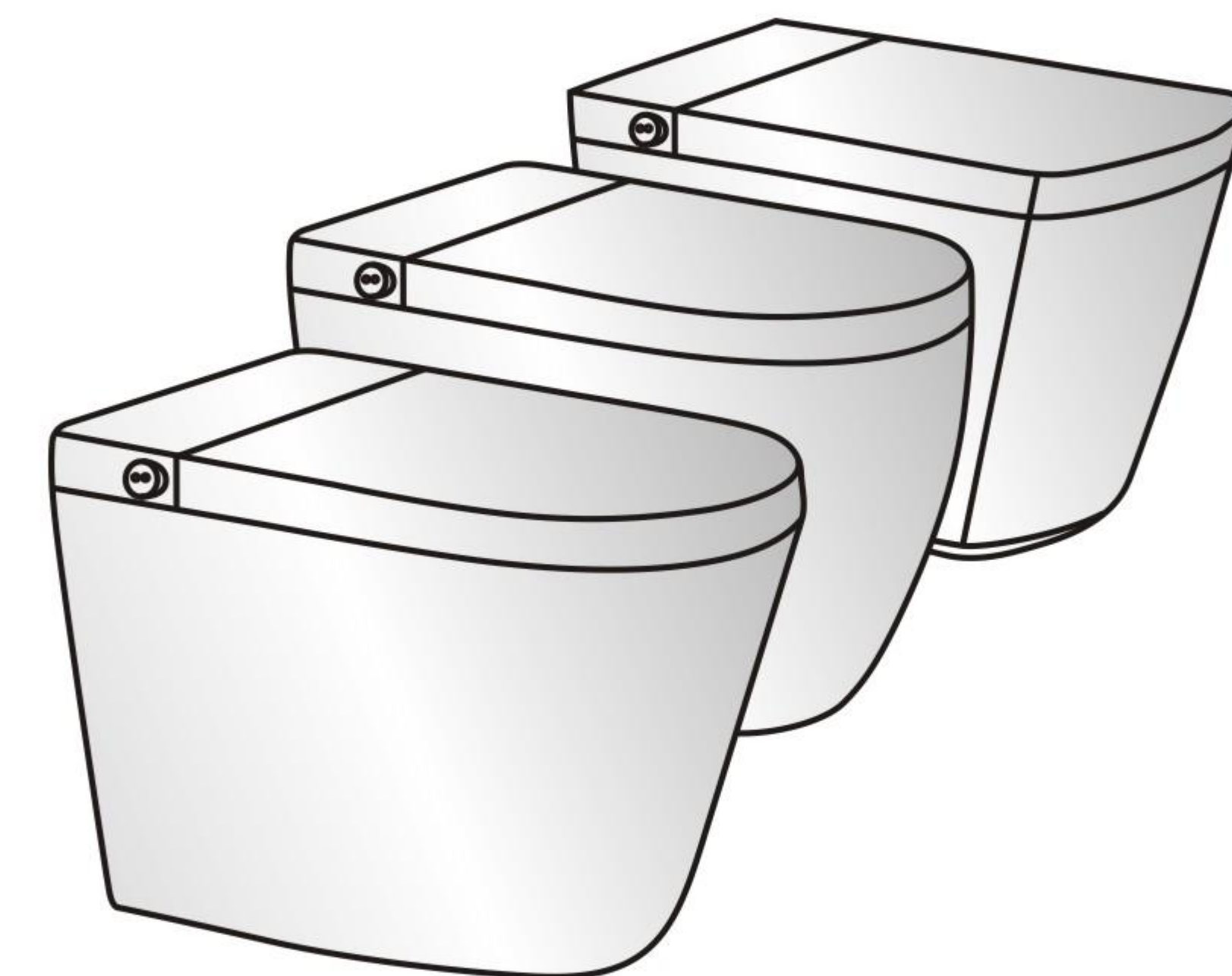

-First of all, we would like to express our most sincere gratitude to you for purchasing our products! -In order to avoid accidents and to use this product safely, please be sure to read the Instruction Manual carefully -Please place the manual in an easily accessible location and keep it in a safe place.

Thank you for purchasing our products, please read the manual carefully and use it correctly, this manual comes with a quality assurance certificate, please keep it in a safe place.
Specialized in Tankless toilet with built-in electronic bidet





Content







Cautions and Warnings	03
Installation instructions	
Packing List	07
Installation method	08
Toilet introduction	
Function Introduction	10
Names of toilet components	11
Function setting and adjustment	15
Daily cleaning and maintenance	22
Fault diagnosis and maintenance	25
Service/Maintenance Guide	29

Cautions and Warnings

Please read these cautions and warnings carefully and use the equipment correctly. Follow all precautions and warnings for your safety.

- ※ In order to prevent the danger of resetting the fuse arbitrarily, enclosed fuse is used. And it cannot be connected to a circuit that is open and closed according to the use of the product.
- ※ The meanings of these indications are as follows.

 WARNING	When this appears next to a topic, this indicates that misoperation could result in death or serious injury.
 CAUTION	When this appears next to a topic, this indicates that misoperation may result in injury or physical damage.
 Required	It means that it must be followed. The meaning of the left image is "strictly abide by"
 Prohibit	This image indicates infeasible, meaning 'prohibited'.

 WARNING	
 Do not disassemble	Never disassemble, repair or modify the device. This could cause fire or electric shock.
 Do not wet	Do not wet the main unit or mains plug with water or cleaning fluid. Doing so could cause fire or electric shock.
 Flammable	Do not bring burning materials near the device. Doing so could cause fire.
 Earthing	Confirm that the earth wire has been installed properly. If the earth wire is not installed, electric leakage or electric shocks could occur. If the earth wire has not been installed, request installation from the business that installed the unit.
 Do not touch with wet hands	Do not remove the mains plug with wet hands. This could cause fire or electric shock.

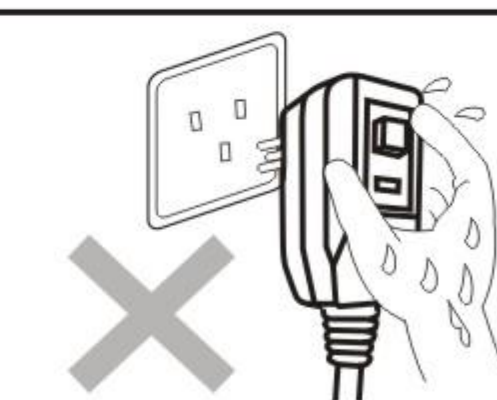

! WARNING

Do not continue to use the device that is broken or malfunctioning.

In the following situations, disconnect the mains plug and close the water shut-off valve to stop the water supply.



Possible malfunctions

- Water is leaking from plumbing or the main unit.
- The device has a crack or a break.
- There is a strange sound or smell.
- Smoke is coming from the device.
- The device is unusually hot.

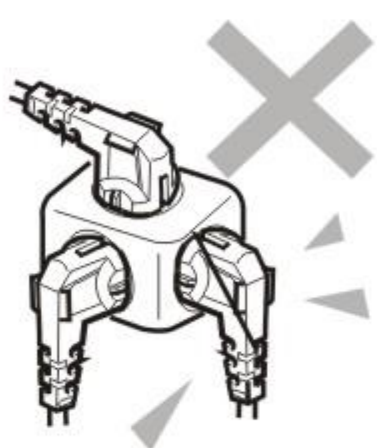

Continued use of a malfunctioning or broken unit could cause fire, electric shock, or flooding of the room containing the unit.

Use only tap water or potable well water (groundwater).

Use of other water could cause skin inflammation or other problems.

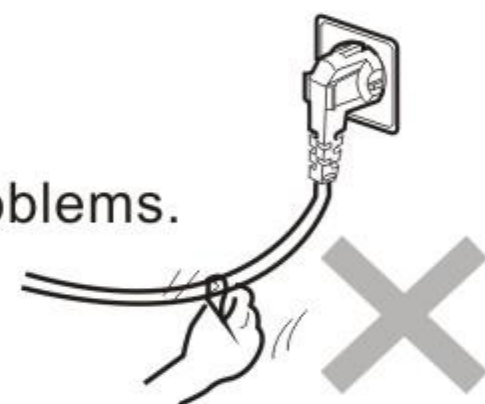

Do not climb on the seat, the toilet lid or any other part of the main unit. Do not put heavy objects on it.

- Injury could result if the device breaks.
- Flooding could result if the device breaks.



Do not block the air openings with finger or other stuff. Do not touch the air openings with hands or cover it with clothes.

Doing so could cause burns or electric shock.

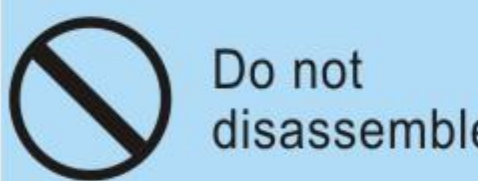

Do not bend or crush the water supply hose.

- This could cause a water leak.
- This could cause low or no water pressure.

When cleaning, use kitchen cleaning detergent.

Do not use scrubbing brush

- Thoroughly tighten the drain valve with built-in water filter or water leak could occur.



Do not detach the drain valve with built-in water filter while the water shut-off valve is still open.

- Doing so will cause water to spill.

Do not discard anything other than excrement and toilet paper into the toilet, .

! WARNING

1. Since this is electronic equipment, do not locate it in a place where it might be splashed or otherwise become wet. When using it in a bathroom, install a ventilation fan or ventilation opening, so that the bathroom has sufficient airflow. (Failure to observe this caution may result in fire or electrical shock.)

2. Install the wiring plug at least 1m away from the floor and keep distance from any bathtub. (Failure to observe this caution may result in fire or electrical shock.)

3. Please use power supply 220V AC, 50 Hz. (Failure to observe this caution may result in fire or electrical shock.)

4. The device is equipped with earth wire.

Confirm that the plug and the earth wire have been installed properly.

5. When installed in a bathroom with a bathtub and a toilet, seal the contact area of the plug and socket with glass glue to prevent water or moisture from entering (otherwise it may cause fire or electric shock.)

6. This equipment is not to be used by any person who has reduced physical, sensory or mental abilities (including children), nor is it to be used by any person who lacks sufficient experience or knowledge. However, such persons may use the equipment when a person who takes responsibility for their safety provides supervision and direction.

7. Children must be supervised to make certain that they do not play with the equipment. If the device has not been treated to repel water, request completion from the business that installed the unit.



Required

Seat heater could cause low-temperature burns.

When seated on the toilet for a long time, turn on the health protection function and low-temperature-burn proof function.

When seated on the toilet for a long time, set the seat heater to "off".

Please turn the seat heater to "off" before the following types of people use the toilet.

- Children, elderly and other people who cannot adjust the temperature suitably themselves.
- Sick or physically disabled people and others who might not be able to move freely.
- People who have taken medication that causes drowsiness (sleep aids, cold medicine, etc.), people who have drunk much alcohol, extremely fatigued people and others who might fall asleep unintentionally.

Thoroughly tighten the water filter

- If not, water leak could occur.

If a water leak occurs, close the water shut-off valve and stop the water supply.

Turn clockwise to reduce the water pressure.



Keep the indoor temperature above 5°C

Freezing could cause damage to the water supply plumbing and the inside of the device and result in a leak.



Precautions for use

Please follow these instructions regarding the device.

Wipe the main unit, seat or toilet lid with a soft wet cloth. When cleaning, use diluted (pH neutral) kitchen cleaning detergent. Do not use the following:
Toilet cleaner, household cleaner (pH acidic or alkaline), benzine, paint thinner, cleanser powders, etc.

● These could damage the plastic or cause cracks, which could lead to injury.



Do not expose to direct sunlight.
--Direct exposure could cause changes in colour or crack, as well as malfunction of the remote control.

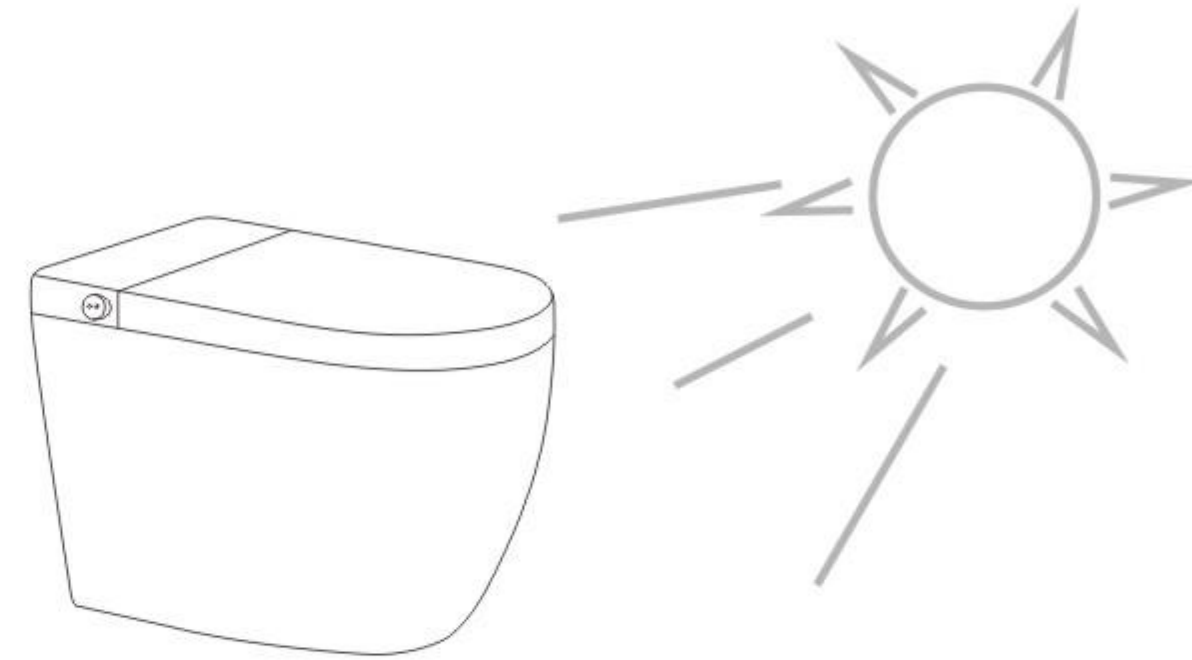

Avoid urinating on the main unit and wand.
--This can cause malfunction.



Do not cover the seat sensor or the signal transmission area of the remote control.
-- This could cause the device to function incorrectly.



Disconnect the mains plug when the device will not be used for a long time.

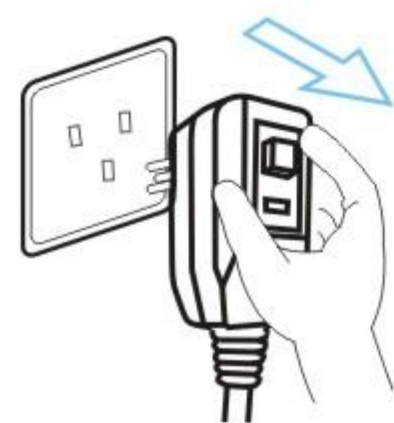

Disconnect the mains plug during thunderstorms.
--This could cause the device to function incorrectly.



Use products such as radios at a certain distance from this product.
-Otherwise, noise may be generated from the radio.

Packing List

Dear user:

After opening the packaging of this machine, please count the following items included in the product packaging box:

1. One toilet all-in-one machine;
2. One user manual;
3. One set of remote control;
4. 1 bottle of foam solution.
5. 1 bottle of aromatherapy or deodorant.
6. 1 set of refilling nozzles.
7. One set of backup battery box; (Before use, it is necessary to bring and install 10 alkaline No. 5 batteries.)
8. One set of filtered inlet angle valve; (Optional double angle valve for reclaimed water)
9. One sealing flange ring or horizontal pipe;
10. Remote control with 1 pair of batteries.

Installation instructions

• Toilet installation

1. Precaution before installing

Ensure that your water inlet pipe and your floor discharge drain are installed. Install toilet at proper position. Inlet water pressure: : 0.15Mpa (dynamic)- 0.75 Mpa (static); Inlet water temperature: 4 °C - 35 °C.

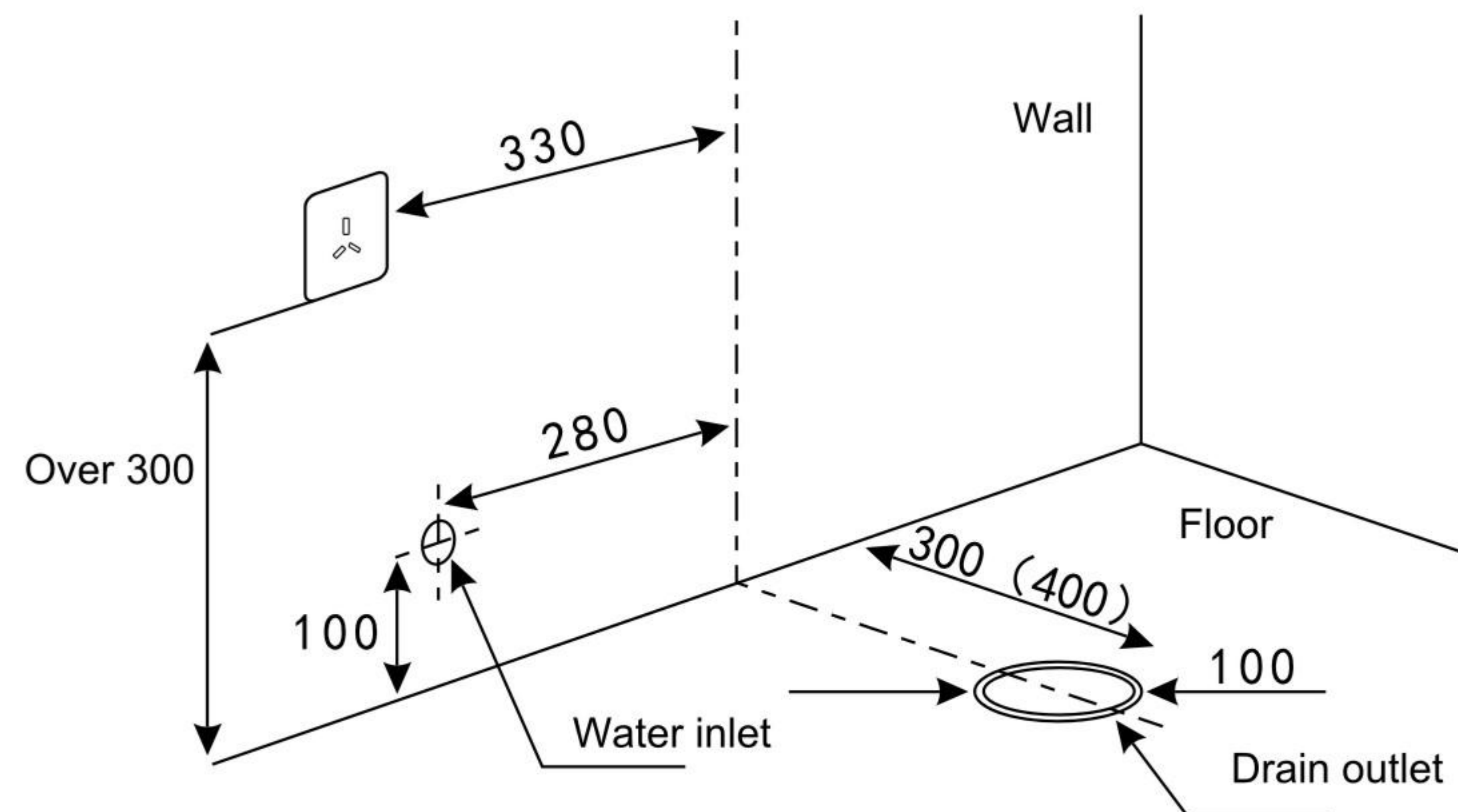

2. Installation of angle valve :

Install the dedicated water inlet valve to the outlet pipe.

NOTE: If there is an old angle valve, it needs to be removed.

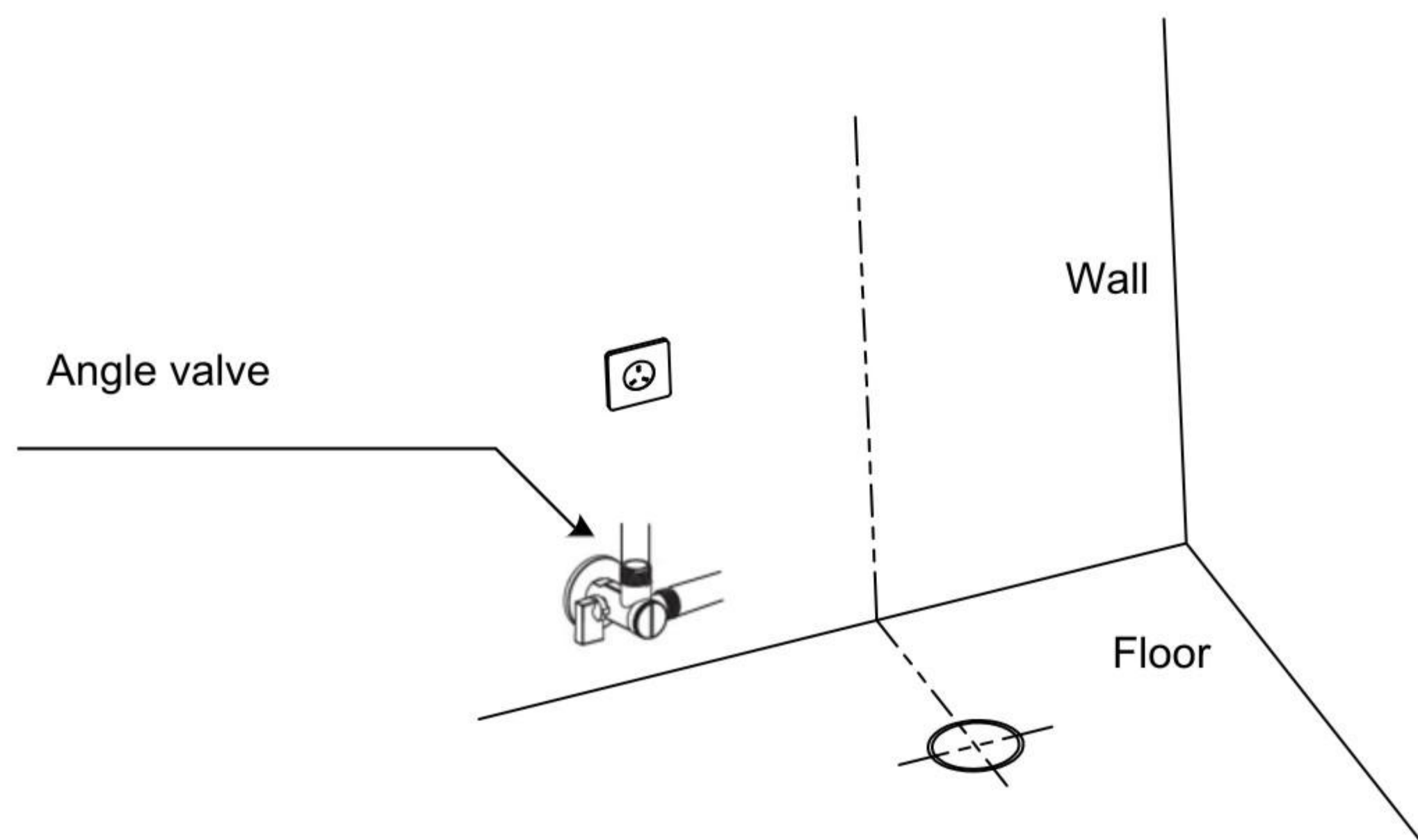

3. Toilet Installation

(1) Apply glue on the upper and lower ends of flange ring, install it into drain outlet. Then install toilet on flange ring, making sure the toilet drain outlet is aligned with the flange holes.

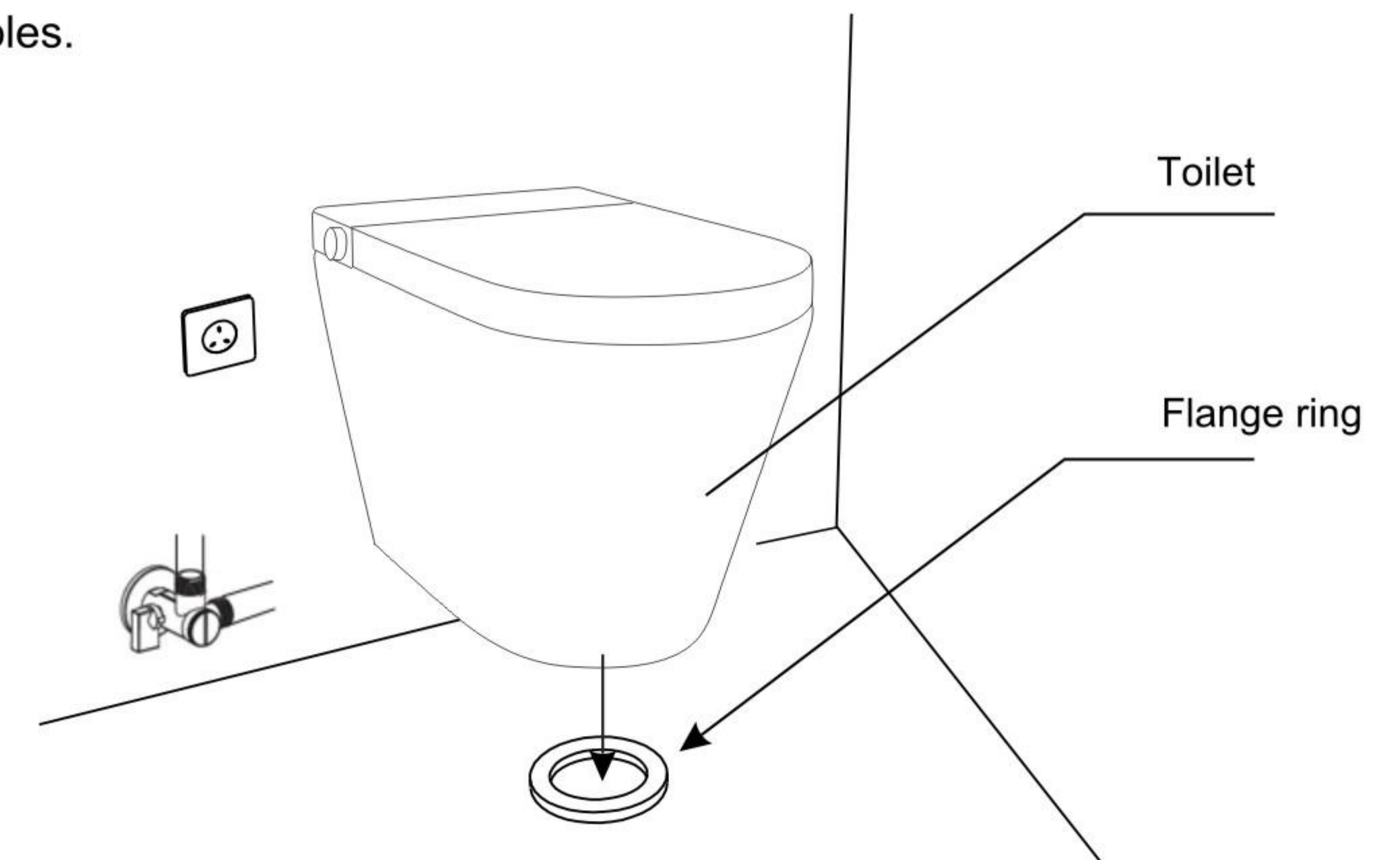

(2) Apply glue between toilet and floor.

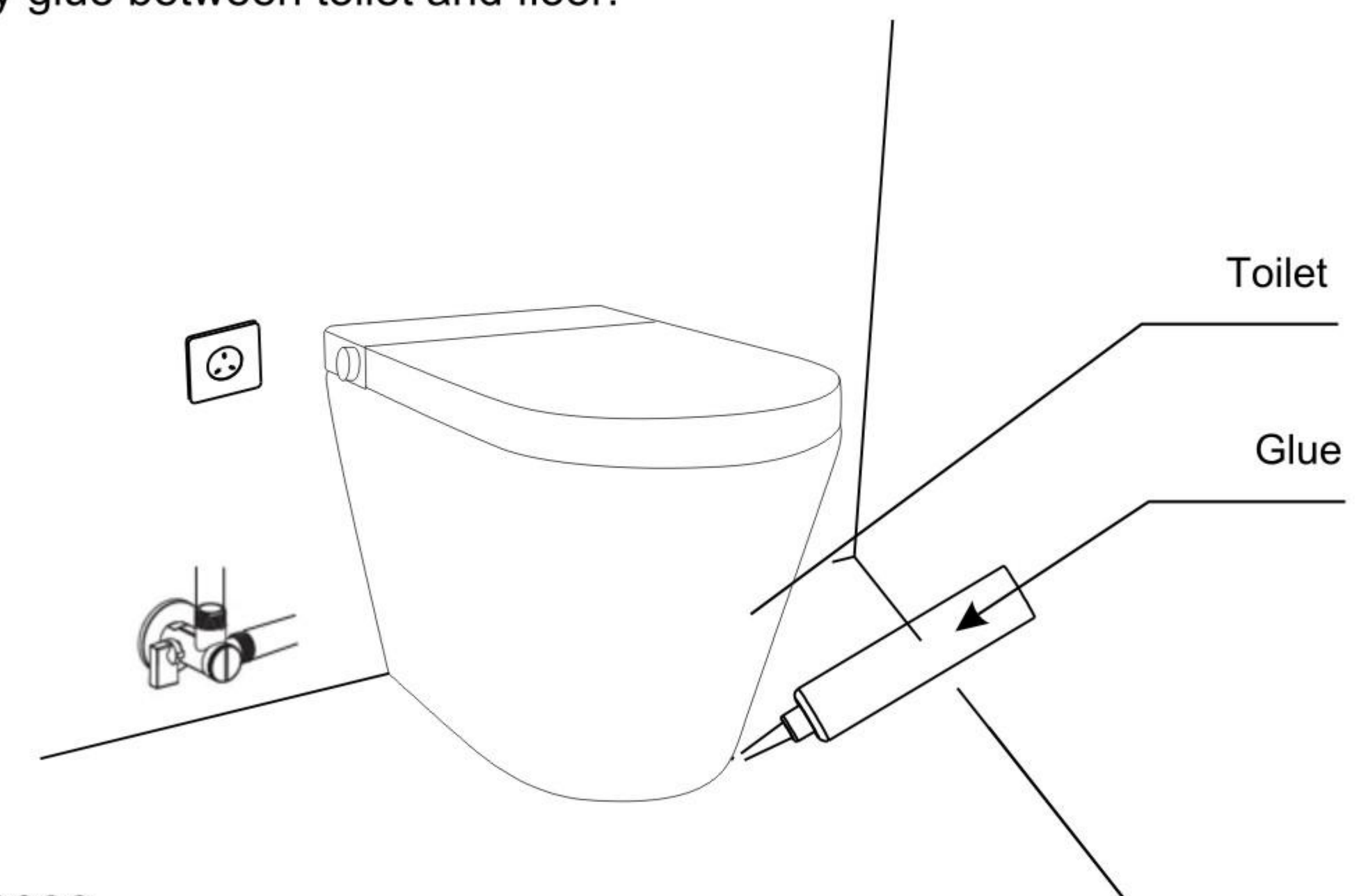

4. Inlet hose

Connect the water inlet and angle valve of the toilet with the matching hose and tighten it.

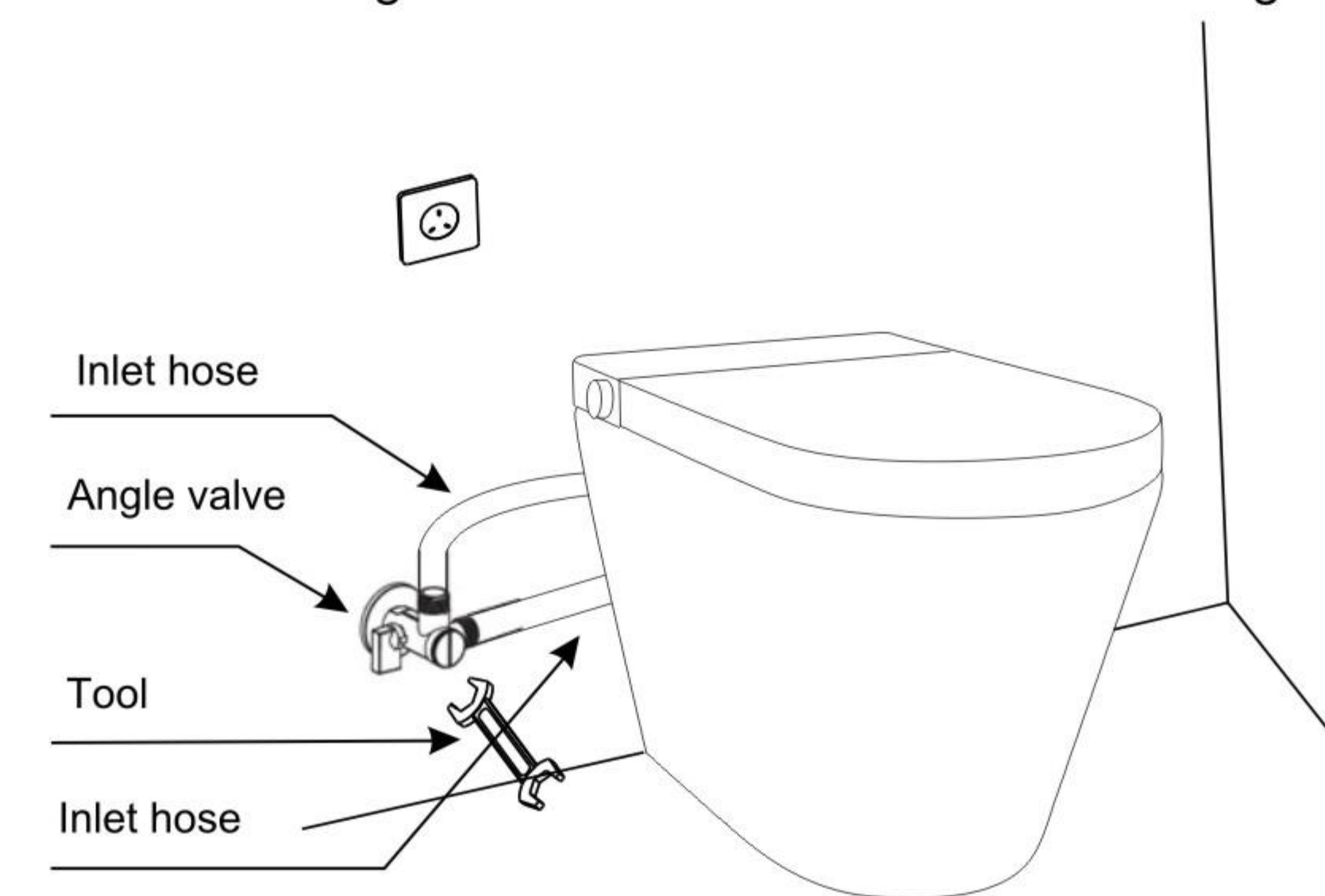

Overview of Features

Category	Function	Detailed description
Basic Functions	Rear wash	Wash the rear.
	Front wash	Use as a bidet for women.
	Child wash	Use as a bidet for women during sensitive periods. Use as cleaning for children without being seated.
	Drying	Use warm air to dry.
	Water pressure adjustment	Adjust the water pressure.
	Washing position adjustment	Adjust the wand position forward and backward.
	Oscillating wash	Moves the wand forward and backward for thorough cleaning over a wide area.
	Massage	Strong and weak water pressure in a row makes people feel like massage.
	Comfort	Turn on oscillating wash and massage function at the same time.
Amenities	Temperature adjustment	Adjust the temperature of the water, seat and drying air.
	Duration adjustment	Adjust the duration of different wash modes
	Remote control	Control the device conveniently.
	Main unit working status indicator light	Display toilet working status.
Optional Features	Auto open/close lid	When the person gets into the sensing range, the lid opens automatically; when the person leaves the sensing range, after 5 mins, the lid closes automatically.
	Open/close seat	When the lid is open, press seat up/down button on the remote control or get into the sensing range to open the seat.
	Voice function	Sterilization with ultraviolet germicidal lamp through offline voice
	Ultraviolet sterilization	control of various toilet functions
	Electrolytic water atomization sterilization	Sterilization of the toilet bowl by electrolytic atomized spraying
	Four seasons temperature sensing seat	Seat temperature control with ambient temperature sensing
Shortcuts	High-speed drying	High-speed blower for drying
	Physical therapy with red light irradiation	Assisted physiotherapy with red light irradiation
	Auto cleaning function	One-touch Cleaning/Massage/Drying/Flushing function.
Comfort Function	Remote control flushing	Press remote control FLUSH button, flush once.
	Auto flushing	When the person left the human body sensing range, toilet will automatically flush once.
	Energy saving	Seat heater enters energy saving status.
Cleaning Function	Low-temperature protection	Prevent people with insensitive skin from low-temperature burns.
	Anticreep	Automatically cut off power supply in case of electric leak.
	Side buttons or knobs	Function operation area other than the remote control
	Self-checking	Self-sensing and giving out alarm when the product is abnormal.
Cleaning Function	Self-cleaning	The wand tip is automatically cleaned thoroughly before and after washing.
	Draining cold water before cleaning	Automatically draining the cold water for added cleaning comfort.
	Foam cleaning	Foam can block odors, clean and prevent splashing.

Names of toilet components

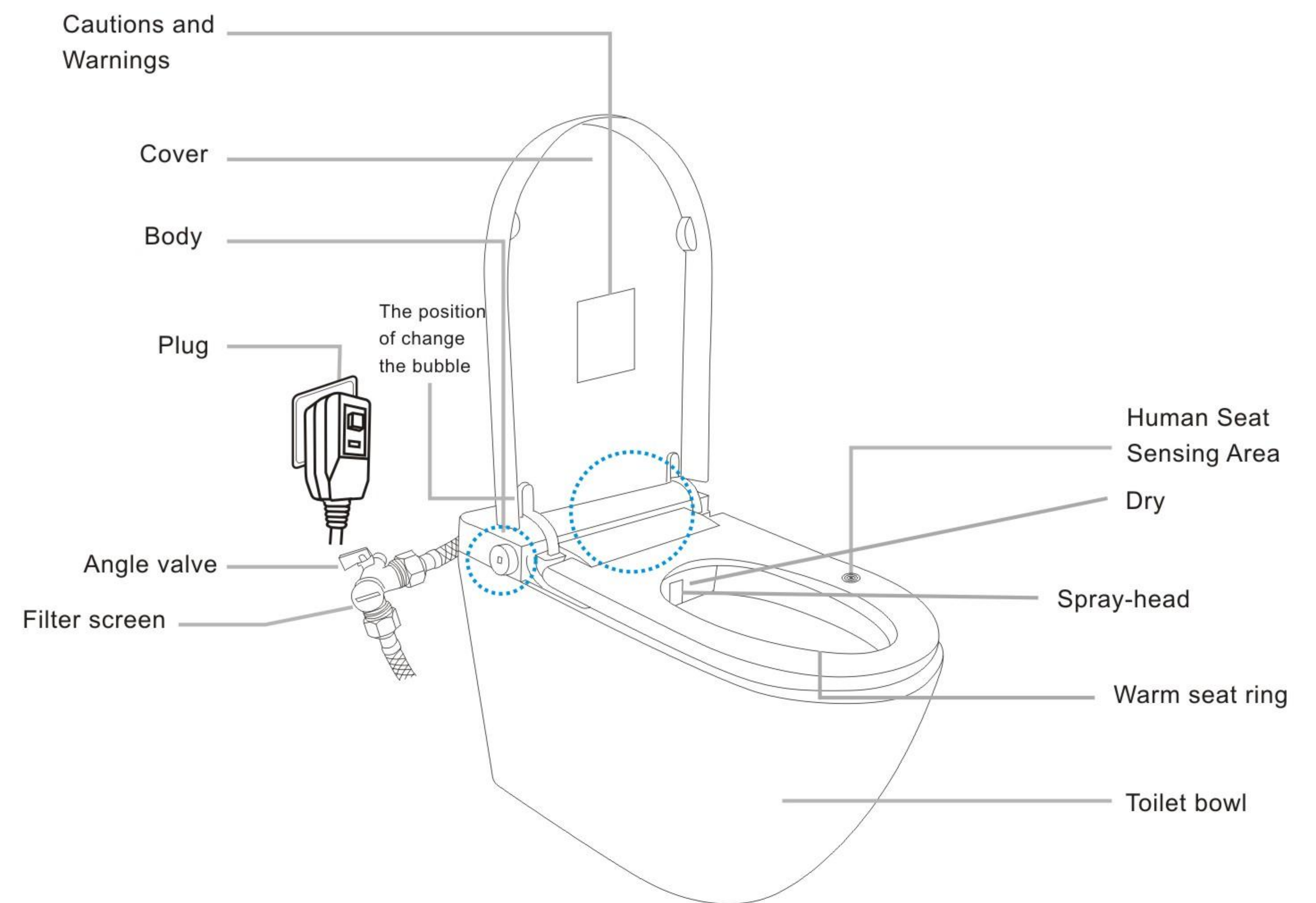

REMOTE CONTROL

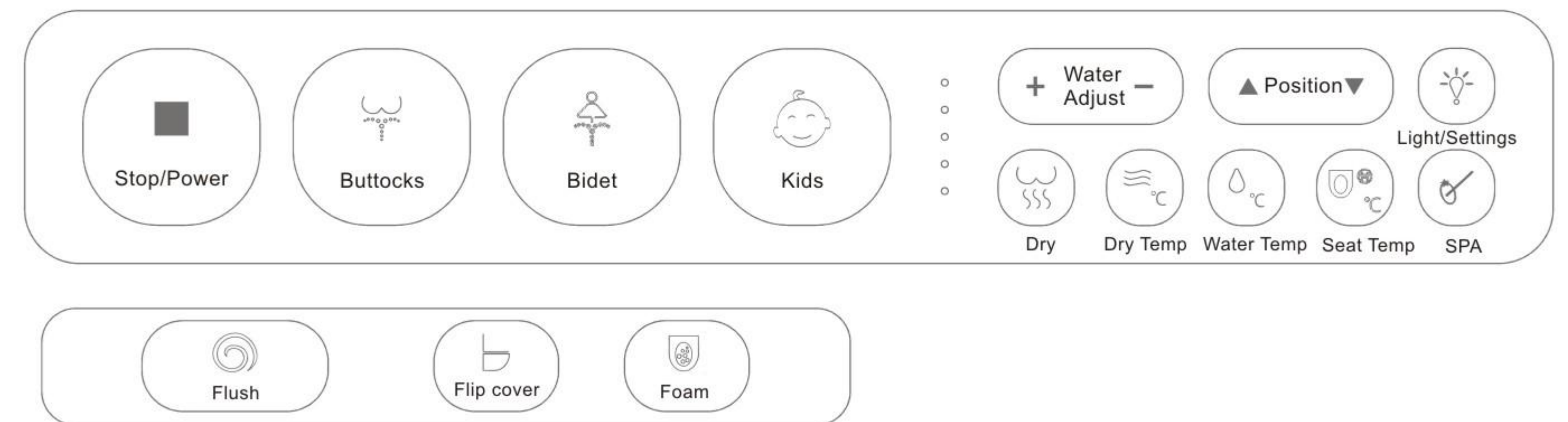

DISPLAY AREA

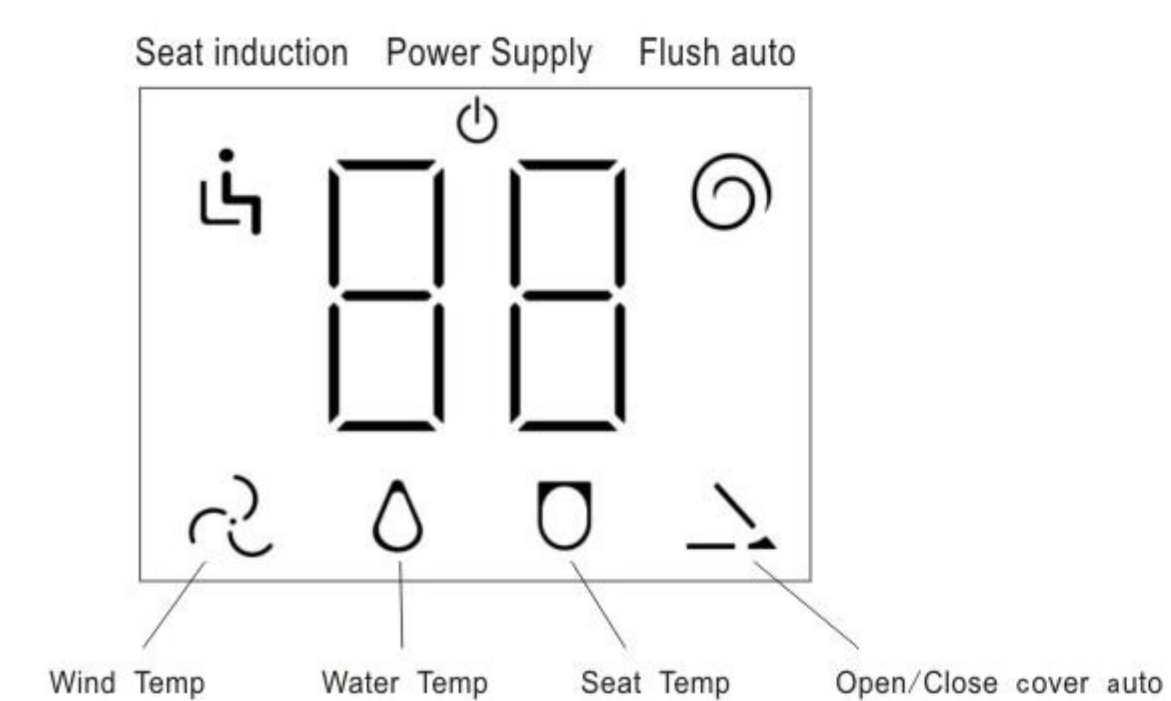

KNOB



KEY

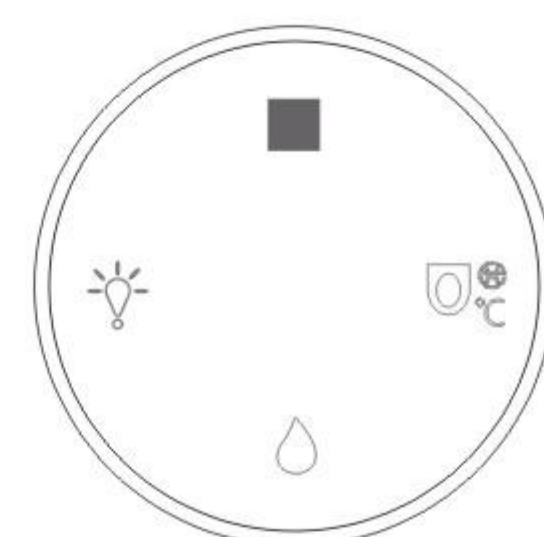

REMOTE CONTROL

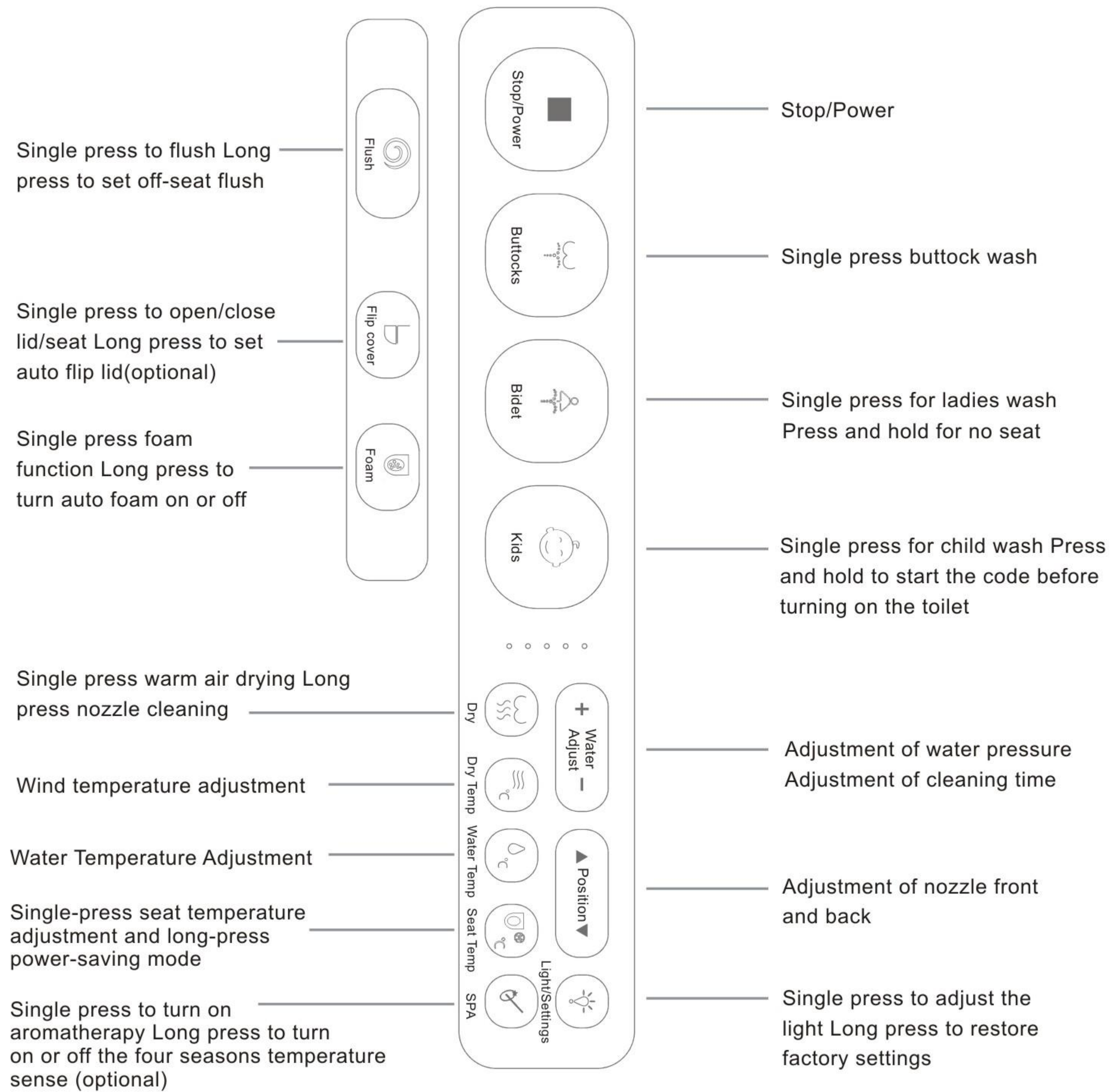

Main unit display

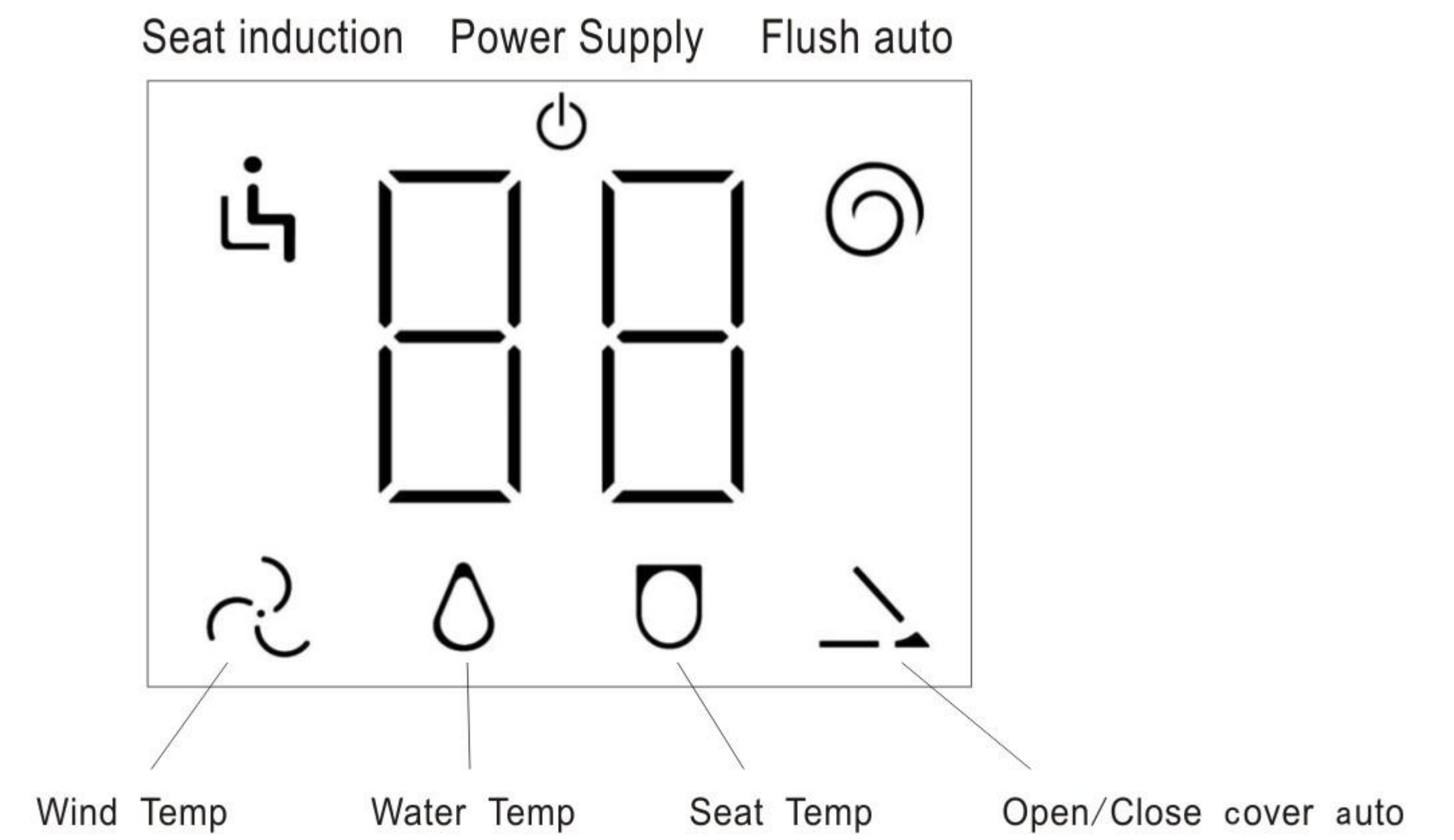

- Temperature level: When the main unit is switched on, the set temperature is displayed.
- Air temperature icon: When the icon is lit, the temperature level shows the air temperature setting level.
- Seat temperature icon: When the icon is lit, the temperature gear shows the seat temperature setting gear.
- Water temperature icon: When the icon is lit, the temperature gear shows the water temperature setting gear.

Mainframe knob or key



Press the knob to switch flushing/stopping

- Non-working state (such as washing, drying, etc.) knob vertical press to flush once, long press more than 6 seconds to enter standby; long press the stop button can enter standby.
- Seat state, clockwise rotary knob or single press the button of the women's wash can open the women's wash one key cleaning function; counterclockwise rotary knob or single press the button of the buttock wash can open the buttock one key cleaning function; single press the knob or stop the key, you can stop the current function (such as buttock wash, women's wash, drying)

Before use

Preparation

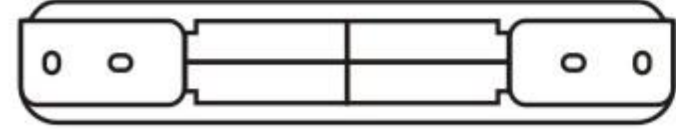

- ① Put batteries in the remote control.
Remove the remote control from the hanger and lift it upward by grasping the ends of the remote control with your hands.



- ② Open the battery cover on the back of the remote control
- ③ Install 2 alkaline batteries according to the icon.
- ④ Close the battery cover

Remote control pair code instructions.

1. When the toilet is powered off, press and hold the remote control until the remote control light blinks and then let go.
Press the button 
2. Toilet energized, waiting for the toilet automatically and the remote control to match the code pairing success will have a beep tone, the toilet display bright numbers can be pressed (wind temperature or water temperature) button to test.

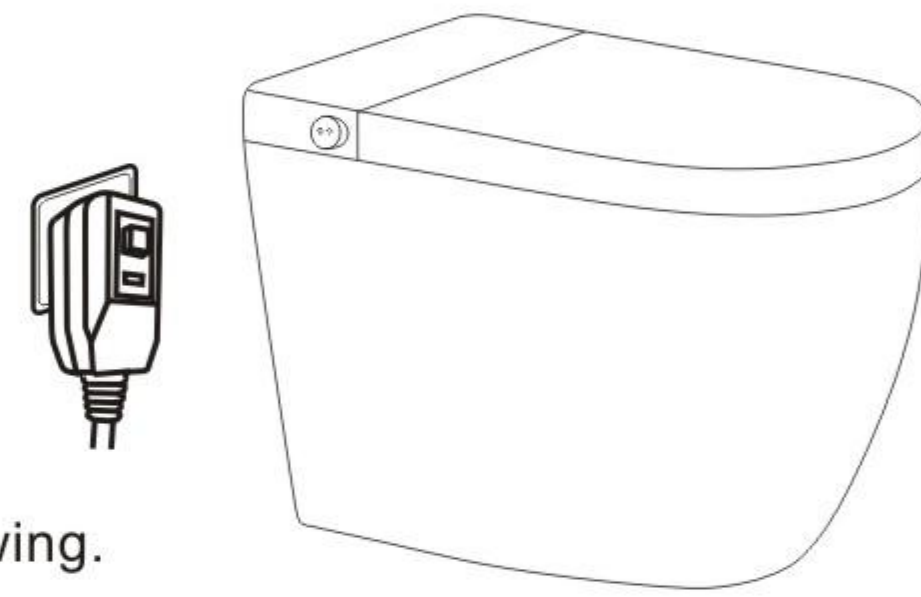

To prevent the batteries from rupturing or leaking liquid, observe the following.
Use two new batteries of the same size 7
Remove the batteries when not in use for a long time.
The current settings (temperature, power saving, auto-flush) may be cancelled after replacing the batteries, so please reset them.

Make sure the mains plug is plugged in to a socket.

Please turn off the main operation section when repairing.



Function Setting and Adjustment

Remote Control Flip Cover and Rim





Open/close lid(optional)

Auto open/close lid--Opening the lid automatically when a person get close to the toilet.

--Closing the lid automatically when a person leaves.

--Hold  for a while to turn Auto open/close lid on/off.

Remote Control Flip Lid and Flip Ring

One press  can open or close the cover, when the cover is open, press the button  again to turn up the seat, when both the cover and seat are open, press the button  to close the seat and cover. When both lid and seat are closed, press the button  to turn up the lid and seat in turn.

Ring Turning (Optional Function)

Foot Sensor - When the foot touches the foot sensor position, the seat will be turned up automatically.

-When the foot sensor is touched again after the seat is turned up, the flushing function is executed.

-When the foot sensor is touched again after flushing, the seat and cover are closed. After the automatic flip-up function is closed, the corresponding flip-up function can be performed by the remote control flip-up button  or the foot sensor.

Sensing distance setting

Long press the buttock wash button under the boot state, the display shows the corresponding number, display 51 represents the near distance, display 52 represents the far distance, this time you can press the remote control wash position button to adjust

Foam Shield (Optional)

Auto Foam - Long press the foam button to turn on or off the auto foam, the toilet will have a corresponding beep. After the function is turned on the seat will be automatically triggered once foaming, within 20 seconds again without repeating the implementation.

Manual Foaming - Single press the foam button  to start the foam function once.

* Foam liquid need to use the original liquid, prohibit the use of detergents, shower gel, shampoo and non-branded original foam liquid If there is a failure or damage after use, the consequences need to be borne by themselves.

Night light ambient light.

One press - button  , the toilet night light and ambient light come on or off in sequence.

The night light in the commode can be automatically controlled by the photosensitive device according to the ambient light condition.

● Flush Function.

Remote Control Flush - Single press the remote control [Flush] button, the toilet performs one flush function.

Knob Flush-Pressing the side knob vertically will flush once.

Side Button Flush-Single press the flush button will flush once.

AUTO FLUSH - After the body leaves the seat, the toilet automatically performs one flush.

-Press and hold the [FLUSH] button to turn on/off the automatic flush function.

Foot Sensor Flush - When the seat and lid are in upturned state, the foot can be close to or touch the foot sensor to perform a foot sensor flush, and the seat and lid will be closed automatically after a delayed period of time. The standard version of the foot sensor can perform a single flush.

One-touch cleaning

After the function is activated, it will first perform 10 seconds of regular cleaning, then pick up 20 seconds of reciprocal cleaning and then 60 seconds of regular cleaning and then automatically proceed to perform the rinsing and 3 minutes of drying function.

● Hip Wash Function.

After contacting the seat sensor point, press the [Buttocks] button on the remote control or rotate the knob on the side of the toilet to perform the wash function.

While the buttock wash function is in progress, it is possible to.

-Single press [Position] to change the wash position by adjusting the gun extension length.

Adjustment of washing water potential: - Single press [water pressure adjustment] to adjust the size and strength of the water pressure of the spray gun, the remote control light on the gear - Single press [water Temp] to adjust the temperature of the water.

Single press [Buttocks] can be adjusted to move the cleaning or fixed-point cleaning, - single press [stop / wash] to adjust the temperature of the water.

-Single press [Stop/Power] to end the hip wash function.

Turn the knob counterclockwise or press the side buttock button to perform the buttock one-touch wash function. The buttock wash function stops automatically after approx. 90 seconds and can be interrupted within 90 seconds by pressing the [Stop/Power] button.

The buttock wash function automatically cleans the spray nozzle when it is activated and the spray gun is extended or when it is retracted at the end of the function.

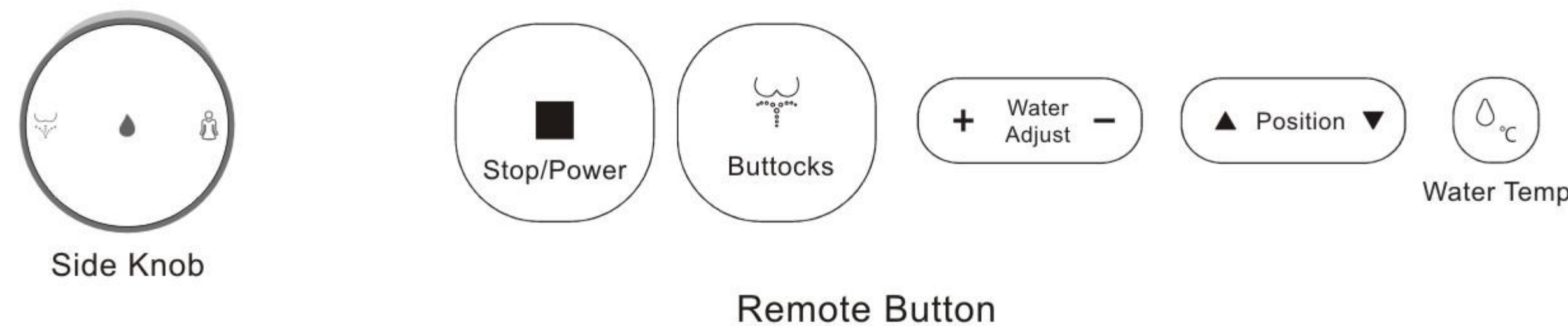

● Bidet washing function.

This product is equipped with a bidet washing function, using women's special soft water flow to clean the skin after contacting the seat sensor point, single press the remote control [Bidet] button, or by rotating the knob on the side of the toilet bowl can be carried out bidet washing function.

During bidet washing function, it can do:

-Single press [Position] to adjust the length of the spray gun to change the cleaning position.

-Single press [Water Adjust] can adjust the spray gun water pressure size and strength, the remote control indicator light gear - Single press [Water Tem] to adjust the water temperature.

-Single press [Bidet] can be adjusted to move the cleaning or fixed-point cleaning.

-Single press [Stop/Power] to end the bidet washing function.

Rotate the knob clockwise or press the side button for bidet wash to perform the bidet wash one-touch function.

The bidet wash function stops automatically after about 90 seconds, within 90 seconds the start of the bidet wash function can be interrupted by pressing the [Stop/Power] button, the spray nozzle is extended or at the end of the function, the spray nozzle is retracted and it will be cleaned automatically.

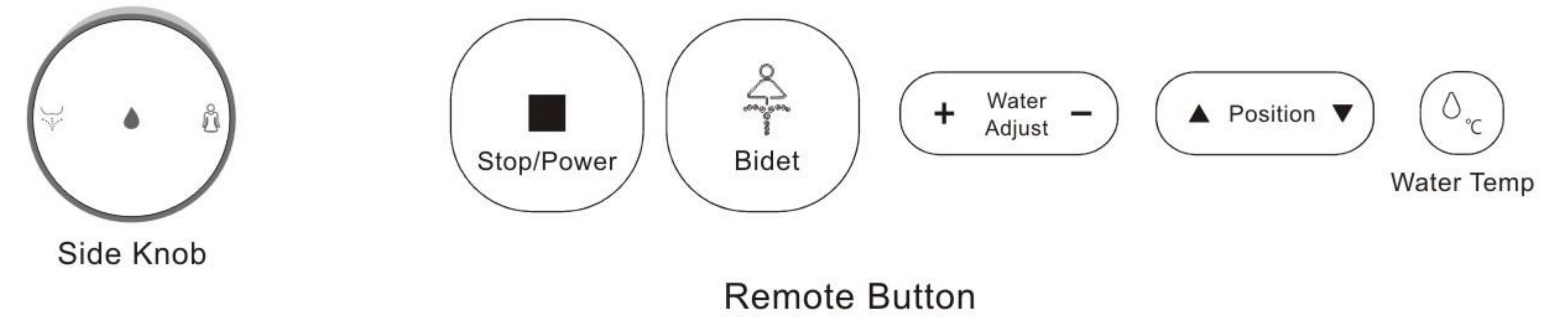

● Adjustment of washing water pressure

In the state of buttock washing or bidet washing, press the remote control [Water Adjust] key.

The water pressure can be adjusted according to your preference.

Multiple levels of water pressure can be selected, when operating the function key [Water Adjust] the water pressure adjustment is activated and adjusted to a comfortable water pressure.

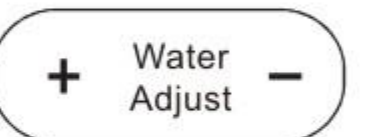

● Wash position adjustment.

In the state of buttock washing or bidet washing, press the remote control [Position] key, you can move the nozzle back and forth to adjust the washing position according to your preference.

4 gear wash positions are available. Operate the function key [Position] to adjust to the appropriate wash position.



● KIDS WASH.

In the state of buttock washing or bidet washing, press the remote control [Position] key, you can move the nozzle back and forth to adjust the washing position according to your preference.

4 gear wash positions are available. Operate the function key [Position] to adjust to the appropriate wash he remote control [Kids] button to activate the kids wash mode.

Press and hold the [Wash] button to turn on the child seatless function.

The corresponding logic is

1. Enable child seat free;
2. Open the virtual long seat.
3. Turn on shielding seat;
4. Unset the status back to normal.

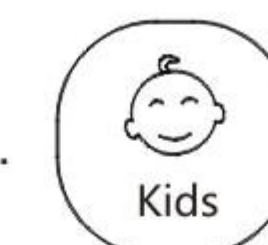
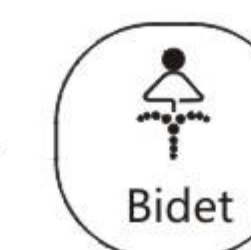

● Adjustment of washing water temperature

The water temperature of the buttock washing function can be adjusted by remote control, please select the appropriate temperature to use, to prevent scalding press the remote control [water temp] button, you can adjust the temperature of the water out of the spray gun, when adjusting the main body of the toilet display will show the temperature change, the remote control indicator will be lighted with the change of the gears, every time you press the water temperature button, switch to another gear.

Temperature a total of 4 gears: room temperature gear, a 34 degrees, the second 37 degrees, the third 40 degrees

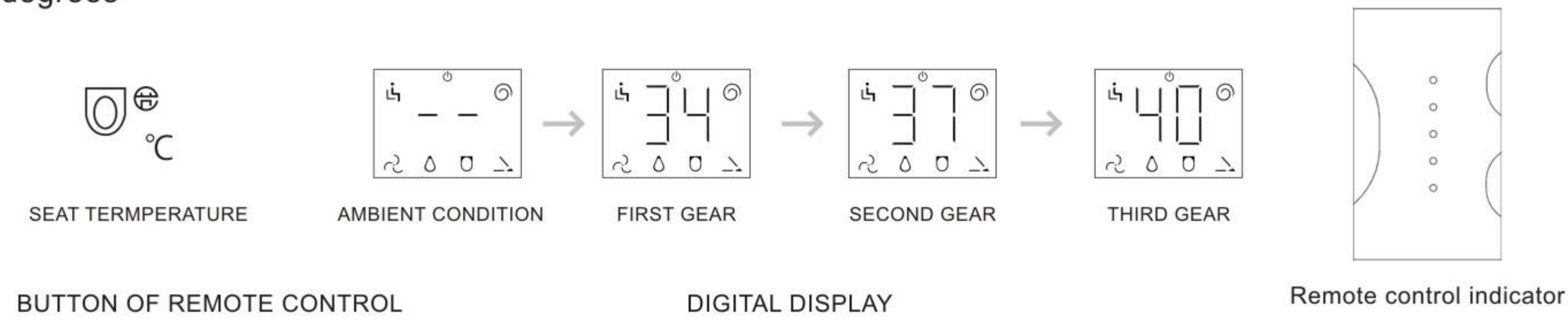

● Seat temperature adjustment.

Seat temperature please choose the appropriate temperature to use, beware of scalding.

Press the remote control [seat temperature] button, you can adjust the temperature of the seat, when adjusting the toilet body display will show the temperature change, if you want to turn off, please adjust to room temperature.

Seat temperature total 4 gears: room temperature gear, first 34 degrees, the second 37 degrees, the third 40 degrees.

-Seasonal temperature sensing seat temperature, through the environmental temperature sensing to control the seat temperature (optional)

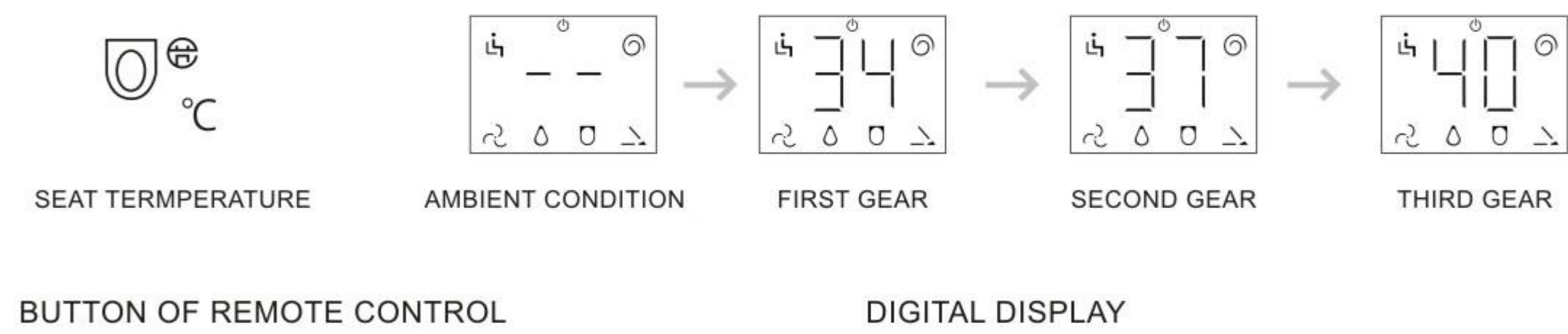

1. When the seat temperature is turned on the main body display panel bit seat temperature display lamp will light up.
2. When the warm water temperature is turned on, the warm water temperature display lamp in the main display panel will light up.
3. When the warm air temperature is turned on, the drying temperature display in the main display panel will light up. The drying temperature display in the main display panel will light up when the warm air temperature is turned on.

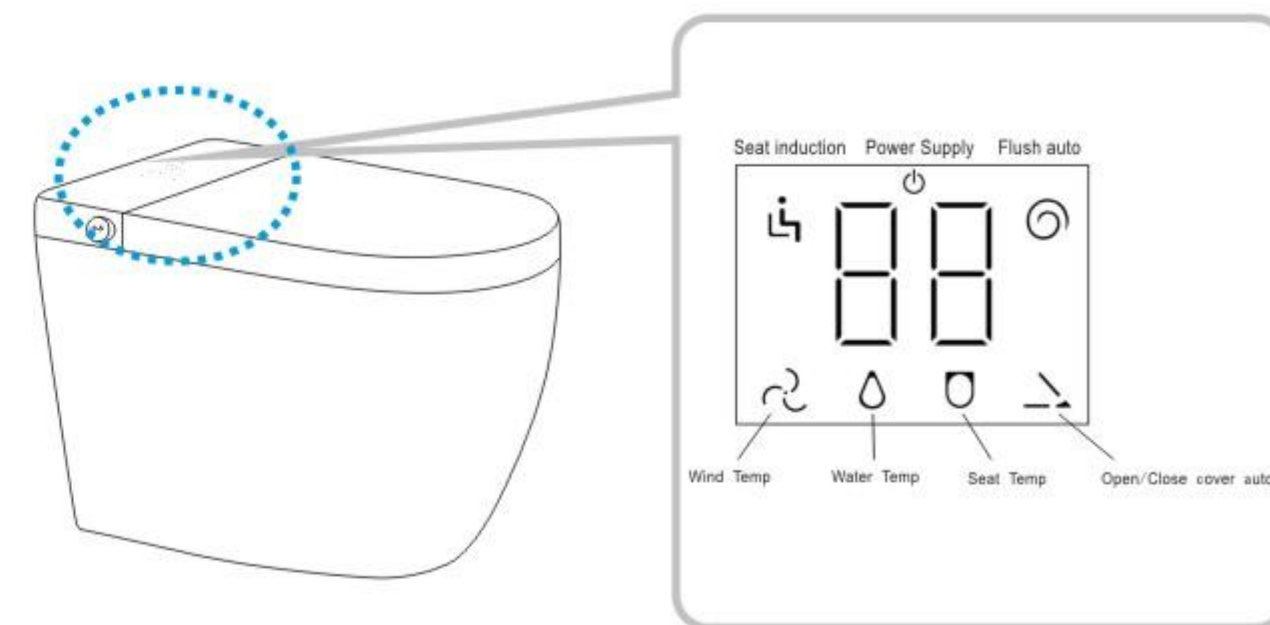

● Drying Function.

Single press the remote control [Dry] button, can be drying function, drying after cleaning wet parts please choose the appropriate temperature to use, beware of scalding. -The drying function stops automatically after about 3 minutes, and can be interrupted within 3 minutes by pressing the [Stop/Power] button of the remote control.

-Press the remote control [air temperature] button to adjust the temperature of the drying air, when adjusting the toilet body display will show the temperature change, the remote control indicator will light up and go out with the change of gear, every time you press the air temperature button, switch to another gear.

The temperature of a total of 4 gears: room temperature gear, a 38 degrees, the second 45 degrees, the third 55 degrees.

-Automatic drying.

, single press [stop] to end the setting long press [stop] toilet drip sound into the setting, single press [wind temperature]

-Enable the function of flushing before drying: long press [stop] toilet drip sound to enter the setting, single press [seat temperature single press [stop] to end the setting.

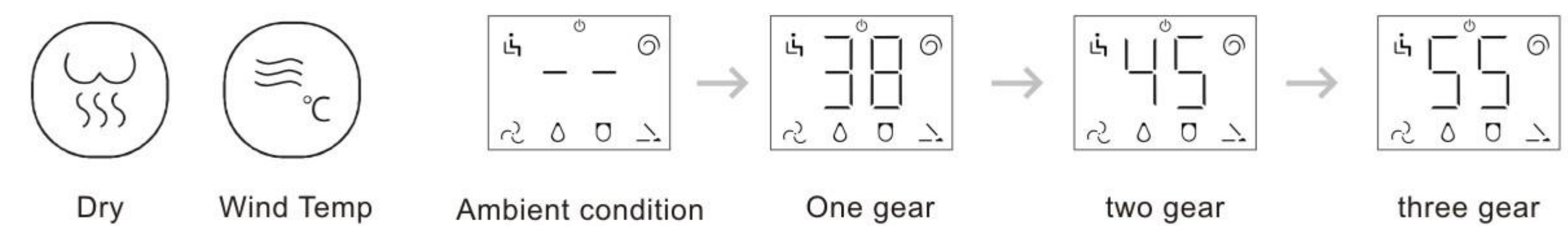

● Energy saving standby.

This machine has automatic energy saving and standby function, such as the toilet in the boot state for three consecutive days without any operation automatically enter the power-saving state, such as four consecutive days without any operation will automatically enter the standby state, in the need to use at any time any key to wake up.

If you need to manually enter the energy-saving state, you can long press the seat temperature button to open, open the seat temperature on the display shows 30 degrees, with the seat automatically into the set gear, the human body away from the seat automatically restore the energy-saving mode.

● **Cleaning nozzle.**

Long press the drying button  to open the cleaning nozzle state, at this time the water from the nozzle self-cleaning mouth outflow, while the cleaner forward, during this period can be cleaned on the nozzle, a single time cycle of 2 minutes, can be repeated on.

● **Adjusting the cleaning time of the spray gun.**

In the state of buttock washing or gynecological washing function, long press the water pressure adjustment button to adjust the cleaning time of the corresponding function, the default time is 90 seconds. The default time is 90 seconds. The single adjustment time is 30 seconds, can be set within 1-4 minutes according to your own preference, with memory.

● **Anti low temperature scald .**

When the seat temperature heating state is turned on, after 3 minutes with the seat will automatically set the temperature of the seat ring down to about 30 degrees to prevent prolonged use leading to low-temperature burns, and automatically recover after leaving the seat.

● **Moistening Function.**

After seating the toilet, the toilet will flush a small amount of water to moisten the ceramic wall, effectively preventing hanging dirt.

-Long press [stop] toilet drip sound into the setting, single press [water temperature], single press [stop] to end the setting.

● **Aerosolized Aroma.**

This product has aromatherapy deodorizing function, the aromatherapy spray comes out from the right side of the toilet. The kit comes with a refill funnel and 1 bottle of aromatherapy or deodorant. You can contact the customer service of each shopping platform for the refilling method.

-Automatic Aromatherapy: Long press the remote control [Stop] key, the toilet drips to enter the setting, single press the [Aroma] button, the toilet drips sound, single press [Stop] to end the setting.

-Manual Aroma: Single press the remote control [Aroma] button will turn on the aroma function for 1 time. 

● **Adjusting the strength of flap turning circle.**

Under power on state, long press the remote control [Stop] key, the toilet drops sound to enter the setting, wait for the display light to go out and long press the remote control [Butt Wash] to enter the flap turning circle strength setting.

Display word C for flip cover, d for flip circle, press [+ water pressure adjustment -] for adjusting the strength level to the desired level, single press the remote control [stop] to end the setup.

(Non-special circumstances are not recommended to adjust, keep the default)

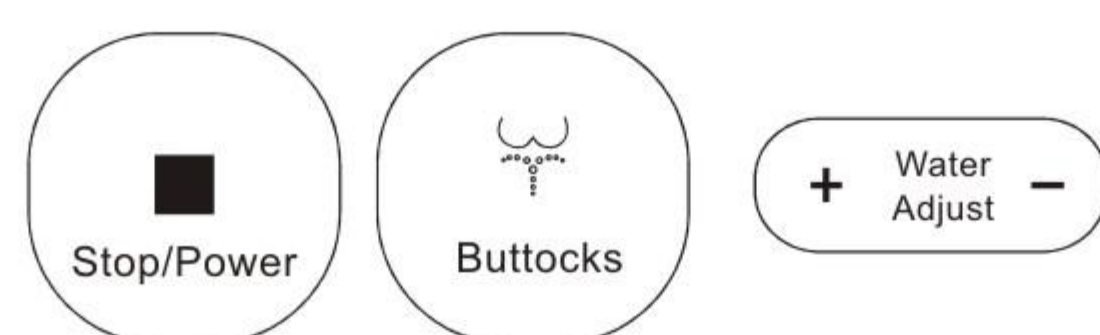

Remote Button

● **Adjusting the flushing water volume gear.**

Under the boot state, long press the remote control [stop] button, the toilet drips into the setting, after the display light is off, single press the remote control [flush] button, press the function key [water adjust], the display shows the word F1, and then press the function key [water adjust] in order to show the F2, F3, F4, F5, F6, F0 for re-adjustment, the default F2 gear. After adjusting to the ideal gear, single press the remote control [stop] key to end the setting.

● **Four seasons temperature sensing seat (optional).**

When the four seasons temperature sensing function is turned on, the toilet will automatically change the set seat temperature according to the temperature feedback from the room temperature sensor, so that the seat temperature is in line with the four seasons of use. Long press the aroma button on the remote control to turn on or off.

● **Voice function (optional)**

This function allows you to operate the toilet through the corresponding voice words.

Wake up the word	FUNCTIONS	
Hi Smart	Turn on Lid	Cool seat temperature
	Turn off Lid	Rise Flow
	Turn on Seat	Decrease Flow
	Turn off Seat	Rise Air Temperature
	Turn on Lighting	Decrease Air Temperature
	Turn off Lighting	Rise Water Temperature
	Turn on energy saving	Decrease Water Temperature
	Turn off energy saving	Position Forward
	Start flushing/Toilet flushing	Position Backward
	Turn on Bubble	Turn on radio
	Rear Wash	Turn off radio
	Female Wash	Turn up voice
	Turn on Warm Air	Turn down voice
	Stop Wash	Open speech recognition
Turn off Warm Air/Stop Warm Air	Close speech recognition	

● **UV sterilization (optional).**

After the lid is opened and the flushing function is executed, the UV lamp will be turned on automatically after the lid is closed manually or automatically to carry out the sterilizing cycle, and will be stopped automatically during the lid opening action.

● **Electrolysis water atomization sterilization (optional): after opening the lid and the**

implementation of the flush function, manual or automatic closing of the lid will automatically turn on the point of hydrolysis after spraying the bucket for sterilization.

● **Red light irradiation physiotherapy (optional) the function is turned on, will be in the**

buttock wash or gynecological wash during the use of red light irradiation function, can promote the metabolism.

Daily cleaning and maintenance

● Cleaning and maintenance of the power plug.

Please clean the power plug regularly: When cleaning, unplug the power plug from the outlet well wipe it with a dry cloth.

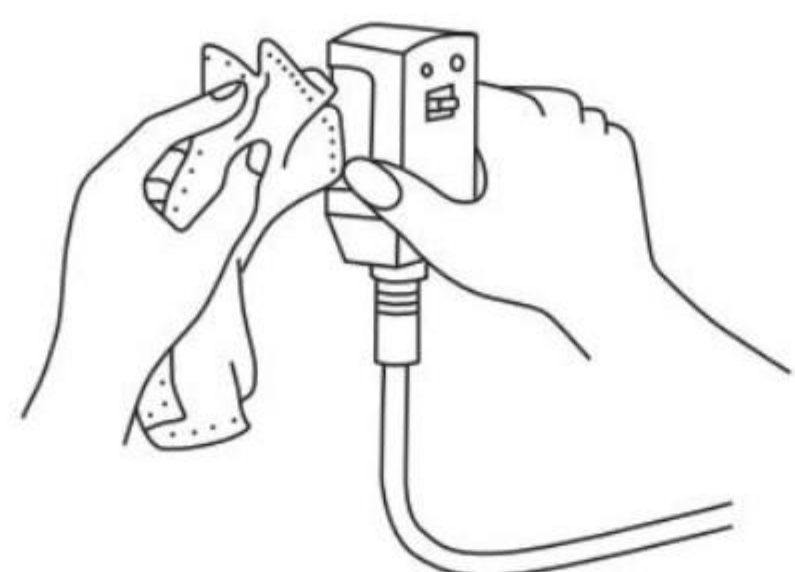

*Dust buildup on the plug may cause a fire.

● Cleaning and maintenance of the main unit of the Smart Toilet.

When cleaning the surface of the main unit, wipe it with a soft cloth moistened with water.

*When cleaning and maintaining, first unplug the power plug from the socket to avoid the power plug coming into contact with water.

*When there are stubborn stains on the surface of the product, use a soft cloth dampened with kitchen detergent (neutral) to scrub.



This product is an electronic product, please take care to prevent water from entering inside the product. Keep the sensor area of the touch base clean.

A dirty sensor area may cause the set function to operate incorrectly or not operate.

● Cleaning and maintenance of the ceramic part of the Smart Toilet.

Pour neutral toilet cleaner into a soft brush or sponge and wash with tap water.

*Do not use detergents or sanitizers that contain scented or acidic solvents.

*Do not use brushes containing abrasive materials.



● Cleaning and maintenance of the water inlet filter.

<1> Close the water inlet valve first and stop the water supply.

<2> Unscrew the filter screen counterclockwise with a coin, do not use any cleaning agent, and Rinse the strainer directly with tap water or wash it with a small brush.

*Do not use too much force when cleaning, otherwise it may lead to deformation of the filter.

<3> Put the strainer back on (the sealing ring on the strainer must not be missed) and tighten it firmly.

<4> Finally open the water inlet valve and check for water leakage. If there is any water leakage, please check again and reinstall.

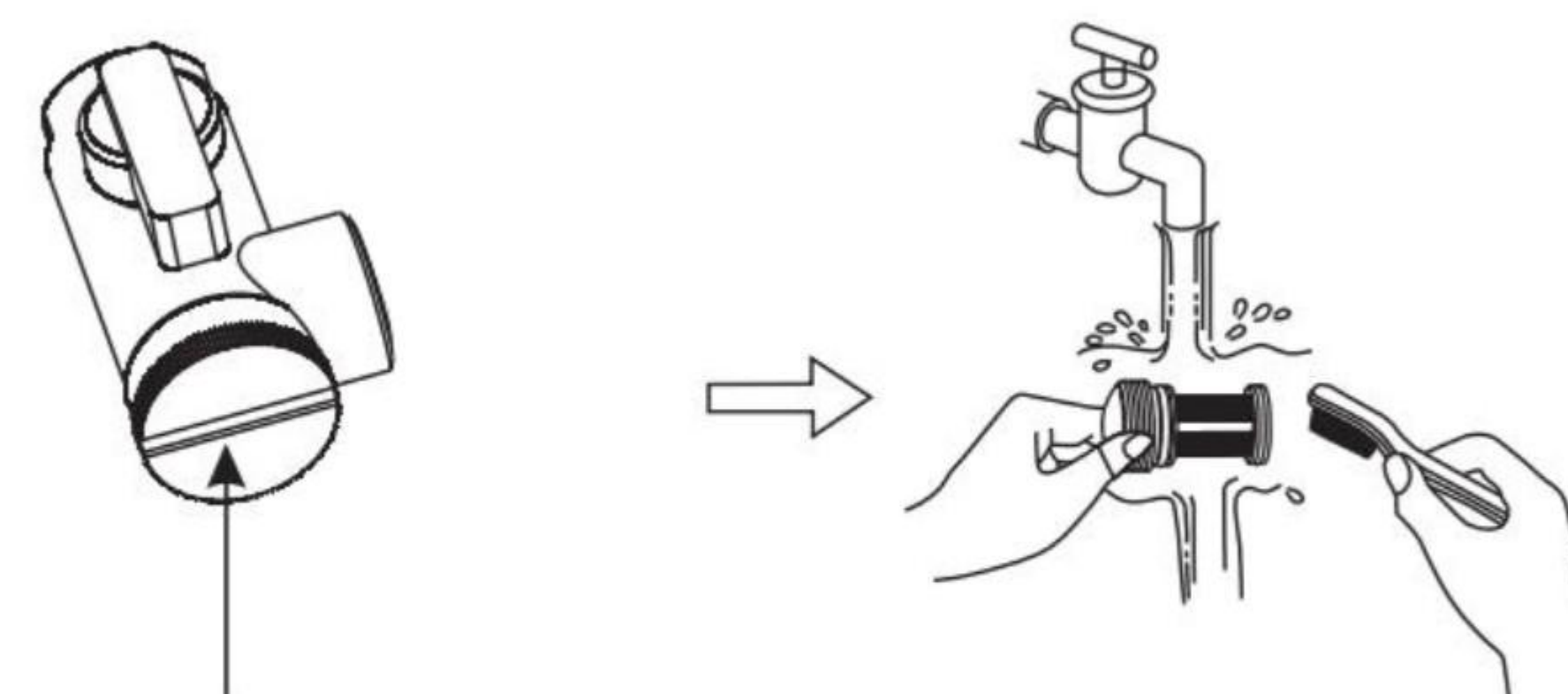

A coin can be used to unscrew the filter counterclockwise

● Freezing occurs.

During the cold season, the Smart Toilet may be damaged due to internal freezing. To prevent freezing from occurring, leave the power on and do the following.

*Set both the seat temperature and water temperature to the highest setting.

*In the unlikely event that the water inlet hose freezes internally and the spray water does not come out, warm the water inlet hose with a cloth soaked in warm water to thaw it out slowly. You can also turn on the heater to warm up the room and thaw it out by yourself.

● Condensation.

Due to the difference in temperature and humidity between the room temperature and the surface temperature and humidity of the ceramic part of the Smart Toilet and the main unit, water droplets may appear on the surface of the ceramic part of the Smart Toilet and the main unit (condensation). Avoid condensation by ventilating the toilet adequately.

*When condensation occurs, wipe with a cloth.

When not in use for a long time:

When this product is not used for a long time, in order to prevent water pollution and water freezing phenomenon, please make sure to drain the water in this product, turn off the power and take out the batteries of the remote control.

<1> Shut off the water inlet valve, stop the water supply, and press once to flush and empty the water tank.

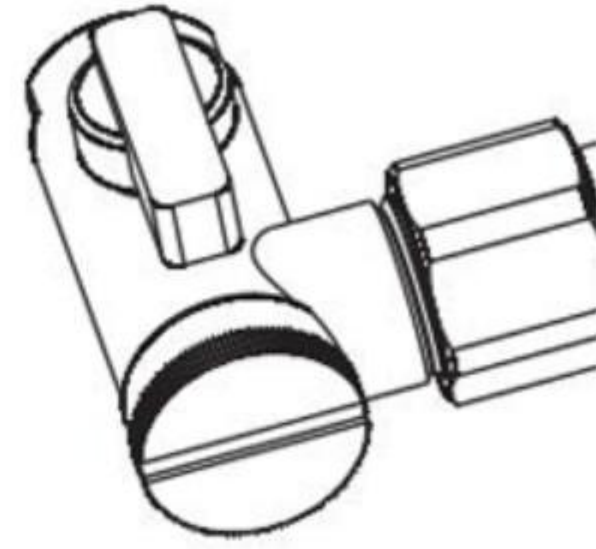

<2> Unplug the power supply from the socket.

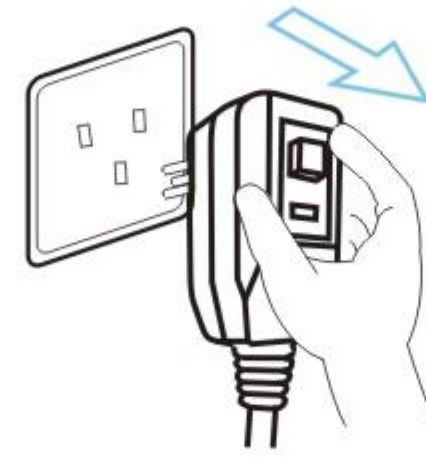

<3> Remove the water inlet hose from the water inlet valve, drain the water from the hose, and install it back. *When you use it again, open the water inlet valve, plug the power plug back into the socket and turn on the machine.

Cleaning nozzle.

Long press the Dry button in non-working condition after power on, can open the cleaning nozzle state, at this time the water from the nozzle self-cleaning mouth outflow, at the same time the cleaner extends forward, and the nozzle can be cleaned during this period.

During this period can be cleaned on the nozzle, single time cycle of 2 minutes, can be repeated open

Cleaning nozzle.

Long press the Dry button in non-working condition after power on, can open the cleaning nozzle state, at this time the water from the nozzle self-cleaning mouth outflow, at the same time the cleaner extends forward, and the nozzle can be cleaned during this period.

During this period can be cleaned on the nozzle, single time cycle of 2 minutes, can be repeated open

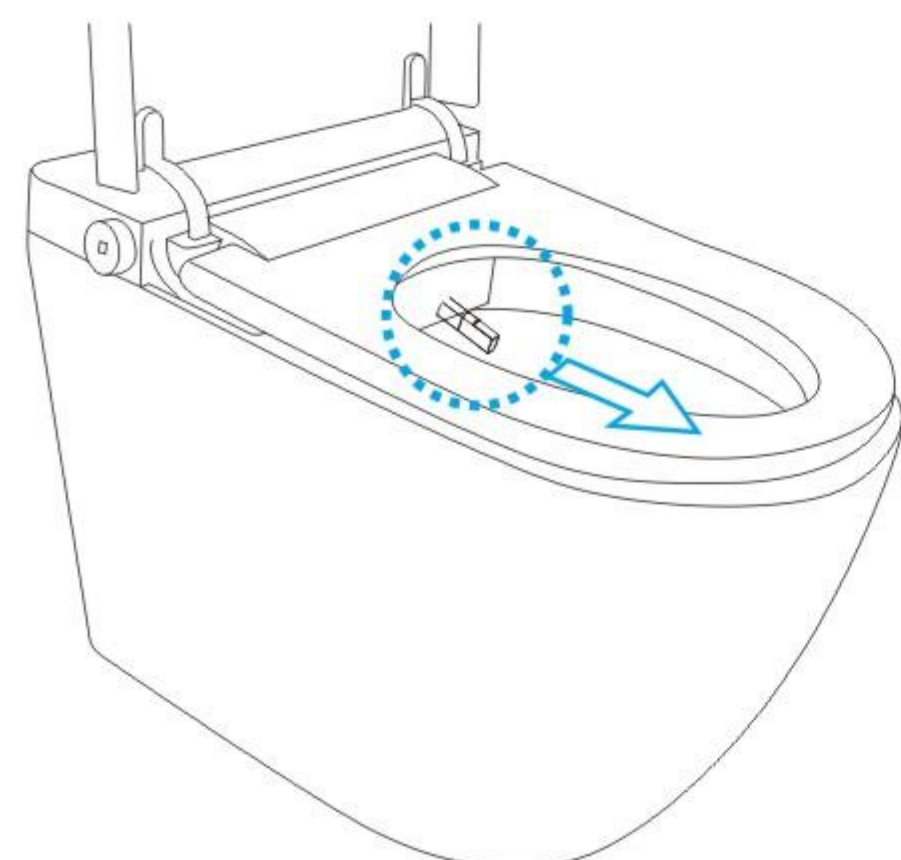

Please use a soft bristle brush or toothbrush to clean.
*Do not pull or push the nozzle or it may cause nozzle damage or malfunction.

Troubleshooting

Please read this section to troubleshoot any problem before requesting repairs. If you still cannot solve the problem after reviewing this section, please contact MOPO customer service center.

※ Please remove the mains plug before repairs.

CAUTION

Required

※ When the wire is damaged, it is the responsibility of the manufacturer, after-sales service center, or a qualified serviceman to replace it to avoid a safety accident. This equipment is not to be used by any person who has reduced physical, sensory or mental abilities, nor is it to be used by any person who lacks sufficient experience or knowledge.

Use the equipment when a person who takes responsibility for their safety provides supervision and direction.

Children must be supervised to make certain that they do not play with the equipment. Use the new hose set included with this equipment. Do not reuse an old hose set.

※ If a water leak occurs, close the water shut-off valve to stop the water supply.







● Please confirm the following points before requesting repair.

Power supply

Trouble	Tests and Results	Solution
Device does not work.	Has there been a power Is Is the main power supply turned on	If there is a power cut wait Mains power supply

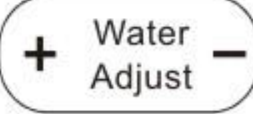
Hip Wash, Women Wash, Children's Function

Failure phenomenon	Judgment (Cause)	Troubleshooting
No water come out of the wash	No rinse water	Wait for water to come.
	Is the water valve closed?	Turn on the water valve.
	Is the sensing area not being touched?	Sit correctly or turn on the no-seat

Trouble	Tests and Results	Solution
Decrease in wash water pressure	Is the set water pressure weak	Press the button on the remote control to turn up the water pressure 
	Is the nozzle or filter clogged	Cleaning nozzles or filters
The water is not warm enough	Whether the warm water switch is turned off or the set temperature is too low	Press the button on the remote control to Adjustment of water temperature 
Water stoppage during cleaning	Pressing buttons stops automatically after about 90 seconds. 	Re-press buttons. 
	Human body may not be touching the touch pad sensors.	Please check the sensing position of the touch base To use the child function, press and hold the button to turn on the seat-free function.
At the beginning of the cleaning process, sprinkle around the nozzle for a few seconds. Sprinkle the inside of the toilet for a few seconds.	When you start cleaning, it is not a malfunction that the nozzle discharges the cold water in the nozzle first in order to avoid cold water spraying out of the pipeline during warm water cleaning, which may affect the comfort of cleaning.	-

Touch-sensitive

Trouble	Tests and Results	Solution
In the unseated state, cleaning is initiated in the following cases	Has the seat been splashed with water or is there a wet towel on it? Or check to see if the no-fall seat is on.	Please use a dry towel to wipe off the water Please move the wet towel away Turn off the non-seated

Auto flushing

Trouble	Tests and Results	Solution
Auto flush function does not work.	Is Auto flush function turned off? (When the function is turned off, the icon is not lit on the remote control display.)	Press Auto flush button to turn on the function. 

Touch-sensitive

Trouble	Tests and Results	Solution
The seat is cold.	Is the seat temperature setting low or off?	Press on the remote control. 
	Is it in energy saving status?	Wait for 1 min after being seated.
The seat temperature becomes lower.	To prevent low-temperature burns, with the seat 3 minutes after the temperature is automatically lowered to a gear, this phenomenon is not a failure, and do not need to reset the temperature of the seat, the next time you use to maintain the original set temperature.	

Energy saving

Trouble	Tests and Results	Solution
After a few days of non-use or the commode doesn't work	Is the power cord unplugged or power outage? Automatically goes into standby after 4 days of non-use	Re-energize and press any key to resume

Remote control

Trouble	Tests and Results	Solution
Remote control functions incorrectly.	Are batteries running out of power?	Change batteries.
	Polarity of battery is reversed.	Please install the batteries correctly.
	Seat sensor does not detect human body.	Use after correctly seating the sensor



Remote control flushing

Trouble	Tests and Results	Solution
Remote control flushing functions incorrectly.	Are batteries running out of power?	Change batteries.
	Whether the flush button is continuously pressed.	Stop for 30s every time after you press the button.
	Seat sensor does not detect human body.	Check the seat sensor position

Bubble functions

Trouble	Tests and Results	Solution
Fail to foam, or make a coarse foam	Maybe the foam is running out.	Replacement with new foam liquid

Warm air drying

Trouble	Tests and Results	Solution
The warm air isn't warm enough.	Whether the drying temperature is set at a low setting	Press button on the remote control to adjust the temperature 
Stopping on the way to drying Warm air drying not working	Press button for 3 seconds to stop automatically 	Please press the button again. 
	Human body sitting position has moved may turn off the touch seat sensor, stop drying function	Please check the seating ring and contact seat
Warm air drying not working	Seat sensor does not detect human body.	Please check the seating ring and contact seat

Other problem

Trouble	Tests and Results	Solution
The water comes up slowly in the water tank.	Is the water shut-off valve fully opened ?	Fully open the valve.
	Is the water filter in the drain valve blocked?	Clean the filter.
	Sharing water with other devices in the bathroom.	-
No water comes out.	Is the water cut off?	Fully open the valve.
	Is a plumbing connection nut loose?	Wait for water.
Water is leaking from the plumbing connections.		Use a monkey wrench or similar tool to tighten the loose part more.

Service / Repair Guide

Please read the section above to troubleshoot any problem before requesting repairs.

- **Warranty (Attached at last)**
 - This manual is accompanied by a warranty certificate, which must be filled in when purchasing. Keep it in a safe place after it is confirmed to be correct.
 - The warranty period is 36 months from the installation date.
- **Spare parts available in the market**
 - The spare parts of the product are available in the market for 5 years since the product production date.
- **When requesting repairs during the warranty period**
 - If you read the manual again and confirm that the product is still abnormal, please contact the customer service center to request repair.
 - Warranty must be provided when requesting repairs.

What to provide when contacting

- Address,name,contact number
- Product name
- Product NO.
- Installation date
- Convenient date for repair

- **When requesting repair for products that exceed the warranty period**
 - Please consult with the dealer or the manufacturer first.
 - According to the customer's requirements, the repair will be charged.

Regular inspections are recommended (charged).

In order to make the product safer, more durable, and more convenient, we recommend that the product be checked regularly for those which have been installed for more than 3 years.

Breakdown of repair costs

The repair cost consists of [technical fee], [spare part fee], and [on-site repair fee].
 [Technical fee] refers to the cost of inspecting failures, repairing and replacing spare parts, as well as inspecting after repairs are completed.
 [Spare parts fee] refers to the cost of spare parts used during repairs.
 [On-site repair Fee] refers to the expenses incurred during the business trip of servicemen.

The Company reserves the right to change these terms and conditions at any time. If there are changes in the product and technical parameters, please refer to the latest version .
 Sorry for any inconvenience.

Specifications

Model	MP-M3/M5/M20 series and ST/A/D expansion series are available.	
Rated power	220 V AC, 50 Hz	
Rated power consumption	1210W(suppose inlet water temperature is 15°C, outlet water temperature and rear water flow as well as seat heater are set to the highest level)	
Maximum power consumption	About 1650W(suppose inlet water temperature is 5°C, outlet water temperature and rear water flow as well as seat heater are set to the highest level).	
Power cord length	1.5m	
Function	Spray volume	About 5L
	Flushing method	Siphonic jet
Cleaning device	Rear wash	Max 0.65 L/min (at 0.2 MPa water pressure)
	Front wash	Max 0.7 L/min (at 0.2 MPa water pressure)
	Child wash	Max 0.41 L/min (at 0.2 MPa water pressure)
	Water temperature	34~40°C
	Heating mode	Instant
	Water heater	1210W(suppose inlet water temperature is 15°C, outlet water temperature and rear water flow are set to the highest level). 1650W(suppose inlet water temperature is 5°C, outlet water temperature and rear water flow are set to the highest level).
	Safety device	Temperature fuse, temperature sensor
Warm seat	Surface temperature	38~55°C
	Heating power	Rated power consumption 250W, different power consumption at different level
	Safety device	Temperature fuse, temperature sensor
Drying	Drying temperature	40~58°C
	Heating power	Rated power consumption 250W, different power consumption at different level
	Safety device	Temperature fuse, thermostat
Cleaning water flow	Cleaning function will stop if the water flow is under 250ml/min.	
Waterproof level	IPX4	
Water supply temperature	5~35°C	
Ambient temperature	5~40°C	
Dimensions	L*W*H 638mm*395mm*450mm	
Weight	42Kg(smart lid 16kg, toilet 26kg)	

WEE guidance



The trademark indicates that this product should be separated from other household appliances during disposal. In order to prevent damage to the environment and the human body, it is recommended to separate, recycle and reuse.

Customers should contact the dealer or a local government agency to determine how it is recycled.

Industrial users should contact the supplier to confirm the purchase conditions.
This product should be dealt with separately from other industrial waste.

Warranty

The company will guarantee the product quality according to the contents of this warranty. Please fill out this warranty when the product fails and contact our service center.

Model:MP-M7	Product NO.	
Name		
Company:		
Address:		
City:		Nationality:
TEL:	FAX:	E-mail:
Dealer		
Address:		
Installation date:		Warranty period
36 months from the purchasing dater		

The content of the warranty must be filled in and confirmed at the time of purchase. Please keep it properly.

Free repair regulations

- MOPO's obligations under this warranty are limited to repair or replacement of products or parts found to be defective, provided that such products were properly installed and used in accordance with this INSTRUCTION MANUAL.
- Please contact the dealer or the manufacturer's customer service center for repairs during the warranty period. Please present the warranty certificate before repair.
- This warranty does not apply to the following items:
 - Damage or loss resulting from any unreasonable use, misuse, abuse, negligence, or improper maintenance of the product.
 - Malfunctions or damage caused by changing installation location.
 - Damage or loss sustained in a natural calamity such as fire, earthquake, flood, thunder, electrical storm, etc.
 - Failures and damage caused by the use of unspecified power supply (voltage, frequency).
 - Used for purposes other than general domestic use.
 - Contents of this warranty cannot be provided.
 - The contents are not completed or the contents are modified without authorization.
- This warranty is valid only in China.
- This warranty will not be reissued if lost, please keep it properly.

About service

Customer rights

Customers have the right to request repair free of charge if a failure occurs within 12 months from the date of purchase. However, Damage or loss sustained in a natural calamity such as fire, earthquake, flood, thunder, electrical storm, etc. is not covered by this warranty.