

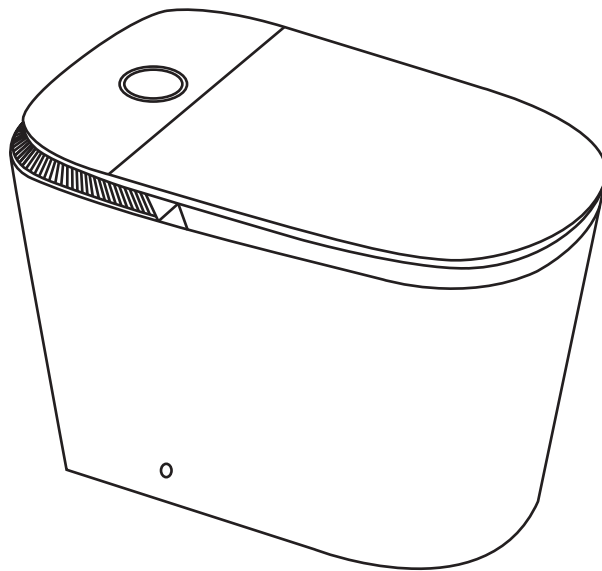

Smart Toilet

Manual



Model: BR30018TAST9W

Phone: 888-257-3857

Website: www.casainc.com

Customer Service: service@casainc.com

Content

1. Product Specifications	1
2. Safety Instructions	2
3. Pre-installation Check	4
3.1 Installation Instructions	5
3.2 Installation Tools	5
3.3 Installation Steps	6
3.4 Function Testing	9
3.5 Remote Control Pairing	9
4. Operation Manual	10
4.1 Operational Functions	11
4.2 Remote Control Functions	12
4.3 Button Functions	13
4.4 Other Functions	14
4.5 User-Friendly Design	16
5. Smart Toilet Maintenance	17
6. Safety Warnings	18
7. Troubleshooting Guide	23

Specifications

Product name		Smart Toilet
Product model		BR30018TAST9W
Lid/Seat open and close		Auto
Product configuration		Rear clean,front clean,foot sensing flushing,power saving mode,pre-flushing,dryer, night light
Rated voltage		120V
Rated frequency		60Hz
Rated power		1200W (When inlet water temp in 59°)
Power cord length		Appx3feet
Water Inlet	Minimum Pressure	35psi, ensuring a flow of water at least 3.7GPM
	Maximum pressure	80psi, ensuring a flow of water at least 3.7GPM
Toilet	Nominal water consumption	1.28gpf/4.8lpf
	Flush method	Siphonic tornado flush
	Rough-in	Rough-in 12in
Cleaning	Heating type	Instant heating
	Washing temp range	(OFF/93°F-104°F)(4 levels)
	Position adjustment	3-level adjustment(long, medium, short)
	Water pressure adjustment	weak, medium, strong, strongest
	Safety device	Butterfly thermostat, thermal fuse, flow sensor, leakage protection plug, watertemperature sensor
Heated seat	Heat temp range	(OFF/93°F-104°F)(4 levels)
	Safety device	Seat occupied sensor,temperature sensor,temperature fuse,temperature controller, leakage protection plug
Dryer	Dryer temperature	4-level adjustment : room temperature, 35°C(95°F), 45°C(113°F), 55°C(131°F)
	Dryer air speed	>4m/s
	Safety device	Thermal fuse, leakage protetion plug, temperature sensor
Deodorization		active carbon
Sensor for open/close seat cover		CapSense
Classi fication of waterproof		IPX4
Ambient temperature		0-40°C
Product size (inch)		27.36" x 15.35" x 20.07"
Product weight (lb)		94.7lbs
Bacteriostat parts		Toilet seat, nozzle
Color		White

Remark: Instructions for details installation, use, clean and maintenance of this product are provided by the manufacturer; only necessary warning sentences required by standards are listed as below. The French manual should be provided by manufacturer if the products shipped to Canada.

IMPORTANT SAFEGUARDS

When using electrical products ,especially when children are present , basic safety precautions should always be followed , including the following

Press the TEST button(the RESET button) every month to assure proper operation
READ ALL INSTRUCTIONS BEFORE USING

DANGER - To reduce the risk of electrocution

- 1.Do not use while bathing
- 2.Do not place or store product where it can fall or be pulled into a tub or sink
- 3.Do not place in or drop into water or other liquid
- 4.Do not reach for a product that has fallen into water . Unplug immediately

WARNING- To reduce the risk of burns , electrocution ,fire or injury to persons

- 1.Close supervision is necessary when this product is used by ,on ,or near children or invalids
- 2.Use this product only for its intended use as described in this manual . Do not use attachments not recommended by the manufacturer.
- 3.Never operate this product if it has a damaged cord or plug , if it is not working properly , if it has been dropped or damaged , or dropped into water . Return the product to a service center for examination and repair .
- 4.Keep the cord away from heated surfaces
- 5.Never block the air openings of the product or place it on a soft surface , such as a bed or couch ,where the air openings may be blocked. Keep the air openings free of lint, hair , and the like.
- 6.Never use while sleeping or drowsy
- 7.Never drop or insert any object into any opening or hose
- 8.Do not use outdoors or operate where aerosol(spray)products are being used or where oxygen is being administered
- 9.Connect this product to a properly grounded outlet only . See grounding Instructions
- 10.Do not use while bathing
- 11.Risk of Electric shock. Connect only to a grounding type receptacle protected by a ground-fault circuit-interrupter(**GFCI**)
- 12.CAUTION- Risk of electric shock , do not remove cover (or back).Refer servicing to qualified service personnel .

Before you install

Water pressure check , dimensional drawing

Confirmation of water pressure

The minimum dynamic operating water pressure is 35 psi , and the maximum static water pressure is 108 psi.

Determination method for minimum water flow

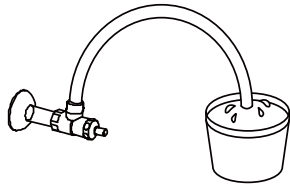

(Tools:stopwatch , measuring cup.)

Open the angle valve for water supply . Ensuring a flow of water at lea 3.7GPM.

If the above conditions cannot be met , the best flushing effect cannot be achieved and an additional booster pump is required to increase the pressure.

Confirm dimensions of product with installation space

BR30018TAST9W

Unit: Inch

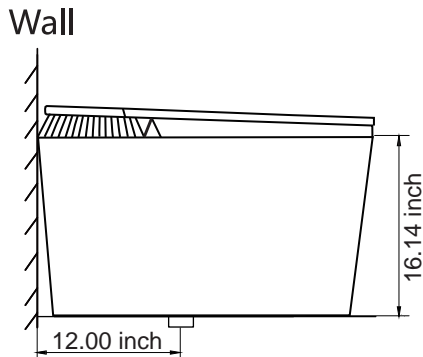

Side profile

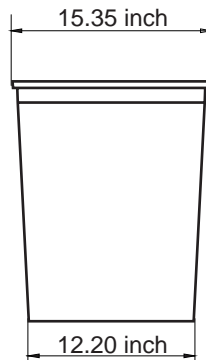

Front view

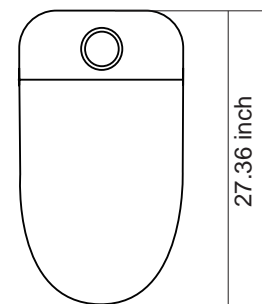

Top view

Intelligent Toilet Installation

Tools required for installation

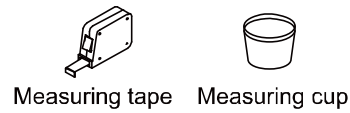
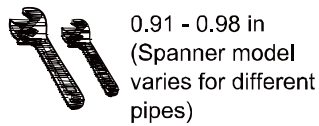

Item list (confirm that all below items are inside the box)

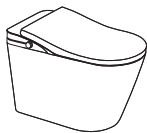

Intelligent toilet(1 set)

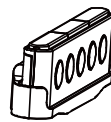

Remote controller set(1 set)

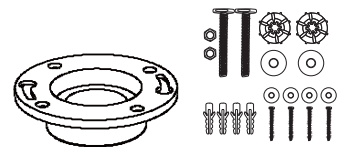

Sealing Flange
Mounting accessory kit(2 pcs)

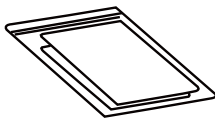

Installation Book & User Manual



Wax Ring(1 pcs)

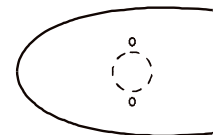

Mounting Template

Please confirm all the aforementioned items are inside the package.
If there are any omissions ,please contact our customer service .

The following are to be purchased by consumers themselves



10 X AA batteries for emergency battery box



2 X AA batteries for remote control

Installing your product

Install your unit using the following steps

- 1** 1 Open the box right side up
 Remove the accessories first , then remove the unit from the top ,
 as shown in the diagrams below.

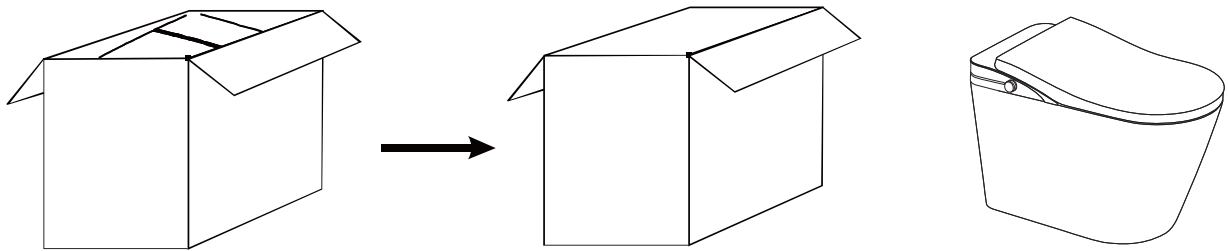

- 2** Mark your drainage hole with a cross

Cardboard installation

- Align cardboard with the centerline of drain outlet
- Draw contour line according to cardboard

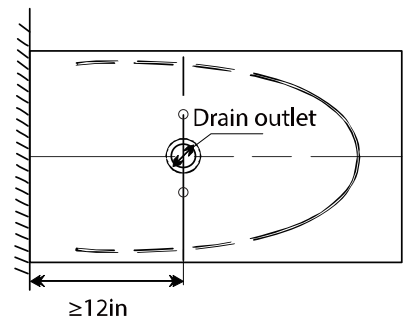

- 3** Mounting bracket installation

Assemble the mounting bracket with bolts and then install them to the pre-installed flange plate on the ground and lock tight with nuts.

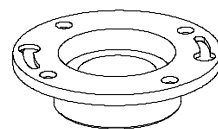

4 Install the ceramic body , water supply hose , T-valve

1.Place the wax ring on the drain hole at the bottom of the ceramic

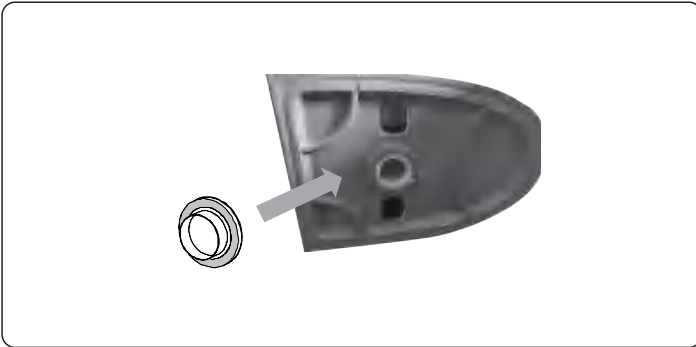

2.Install sealing flange into drain outlet

3.Install ceramic toilet on corresponding position according to contour line

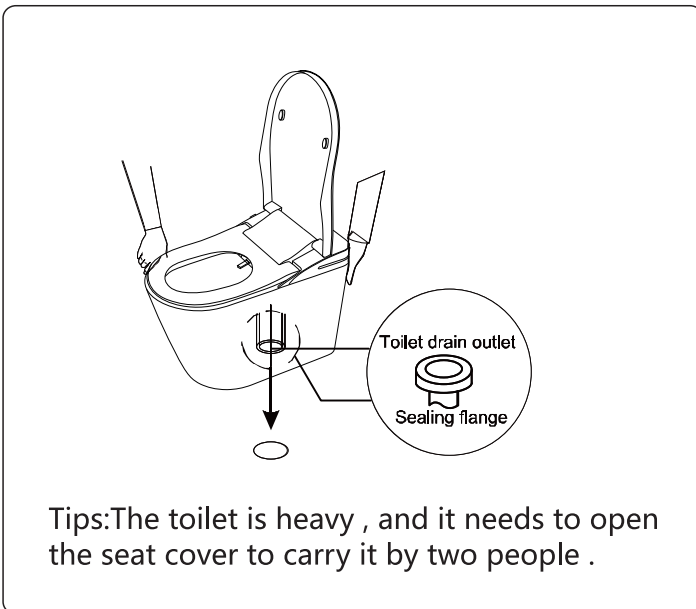

4.Tighten the screws on the two sides of the ceramic

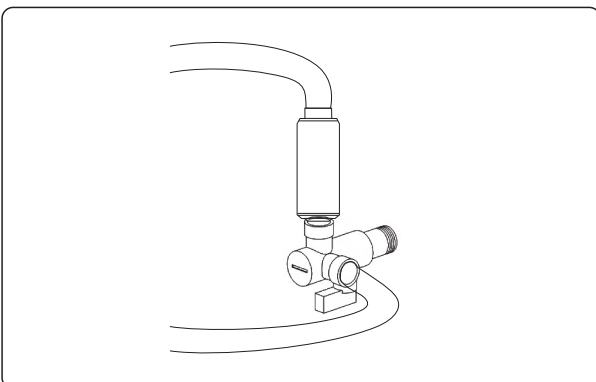

5.Attach the flush water hose to the T-valve and tighten

6.Connect the T-valve to the water supply and tighten. Use gasket to prevent water leakage

7.Finish installation.

5 Installing the remote

1. Drill two 6mm (0.24inch)diameter holes on the wall(about 1.77 inch deep).
2. Knock the anchors into the hole with a hammer.
3. Secure the holder with anchors or use the pasater on the back of the remote control holder to fix it to the wall.
4. Use the screws to secure the holder to the wall.
5. Remove the battery cover from the backside of the remote to install batteries.
6. Once finished, remote is ready to be placed in its holder

Detailed steps shown in the diagram below:

- Please use proper mounting tools for special wall surfaces (such as wood , HDF, etc.).
- The remote control holder should be installed away from the bidet’s spray trajectory.
- The remote control holder should be installed within reach when seated on unit.
- Make sure there is nothing to block the transmission between the toilet and its remote .

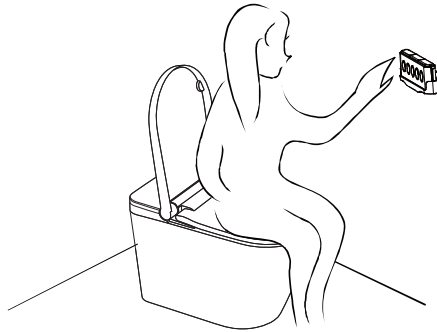

Steps:

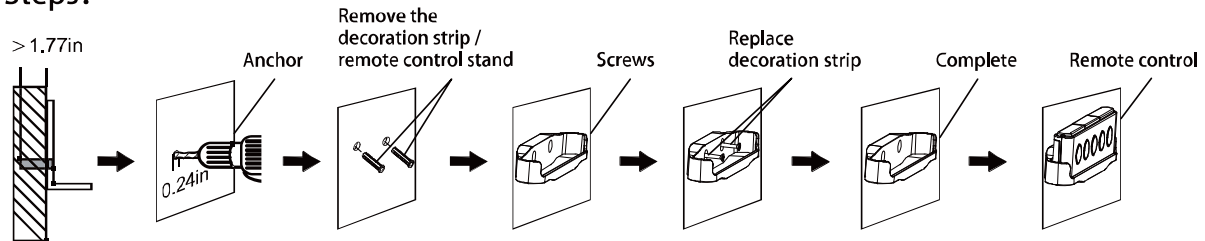

6 Installing and replacing the battery box

Install and replace the emergency flushing battery

1. Open the backup battery box.
2. Install the AA battery in the correct direction.
3. Replace the battery box cover.

*Please confirm the battery’s positive and negative poles .Please do not charge , disassemble, fire the battery ,or mix with used batteries or different kinds of batteries to avoid liquid leakage or explosion.

*The battery box has a moisture-proof function.Please ensure that the set screws are screwed in place to achieve a good seal effect.

*If the battery needs to be replaced . It is recommended to contact your local dealer to have it replaced by specialized personnel.

7 Testing water flow

1. Open the water supply angle valve to maximum as shown in the figure.

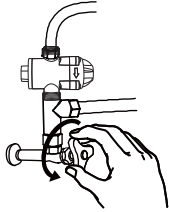

2. Confirm various connecting parts are not waterleaking.
*In case of water leaking, unfasten the nuts again and install them again.

8 Connecting power

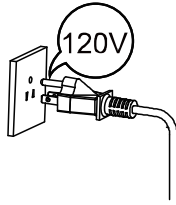

1. Connect to the grounding.
2. Plug in AC 120V power plug.
3. Check to see if the power is on.

(1) Check to see if the power light is on. If not, push the reset button.
(2) Once the power light is on the toilet will run its initial diagnostic: Lights will turn on. Cleaning nozzle will extend, the motor will begin to run and water will run through the system. Once the light is off, the self-diagnostic is completed.
(3) Powered on: Press and hold the knob for 3 seconds to enter the standby mode.

Testing the product

Test whether the functions of the buttons on the remote controller and the knobs on the side of the body are normal. Are all the functions working properly?

Rear Wash, Front Wash (Including water pressure & nozzle position adjustment), Heated Dryer, Water & Seat temperature Adjustment, Nozzle cleaning, Anion Deodorization, Remote control. All functions listed above should be tested.

Checking Rear Wash

Please use your hand to hold the seat sensor area, turn the knob forward or press the "Rear Wash" button on the remote controller, and use your hand to cover the front of the washer to block the flow of wash water to avoid spraying water on your body or clothing.

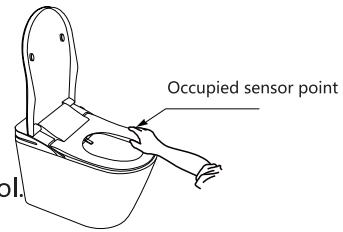

Matching your remote control code

When the product leaves the factory, the remote control and the product are connected, if the remote control went failure, please re-connect the code as following methods.

1. Unplug the product's plug, press the stop key for few seconds until the level light is flickered.

2. Plug the attaching plug when the remote control get closer to the product.

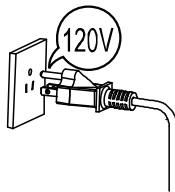

3. The level light stops flickering and then it is lighted on.

4. At the time, the remote control and product is re-connected.

OPERATION INSTRUCTION

Remote Control

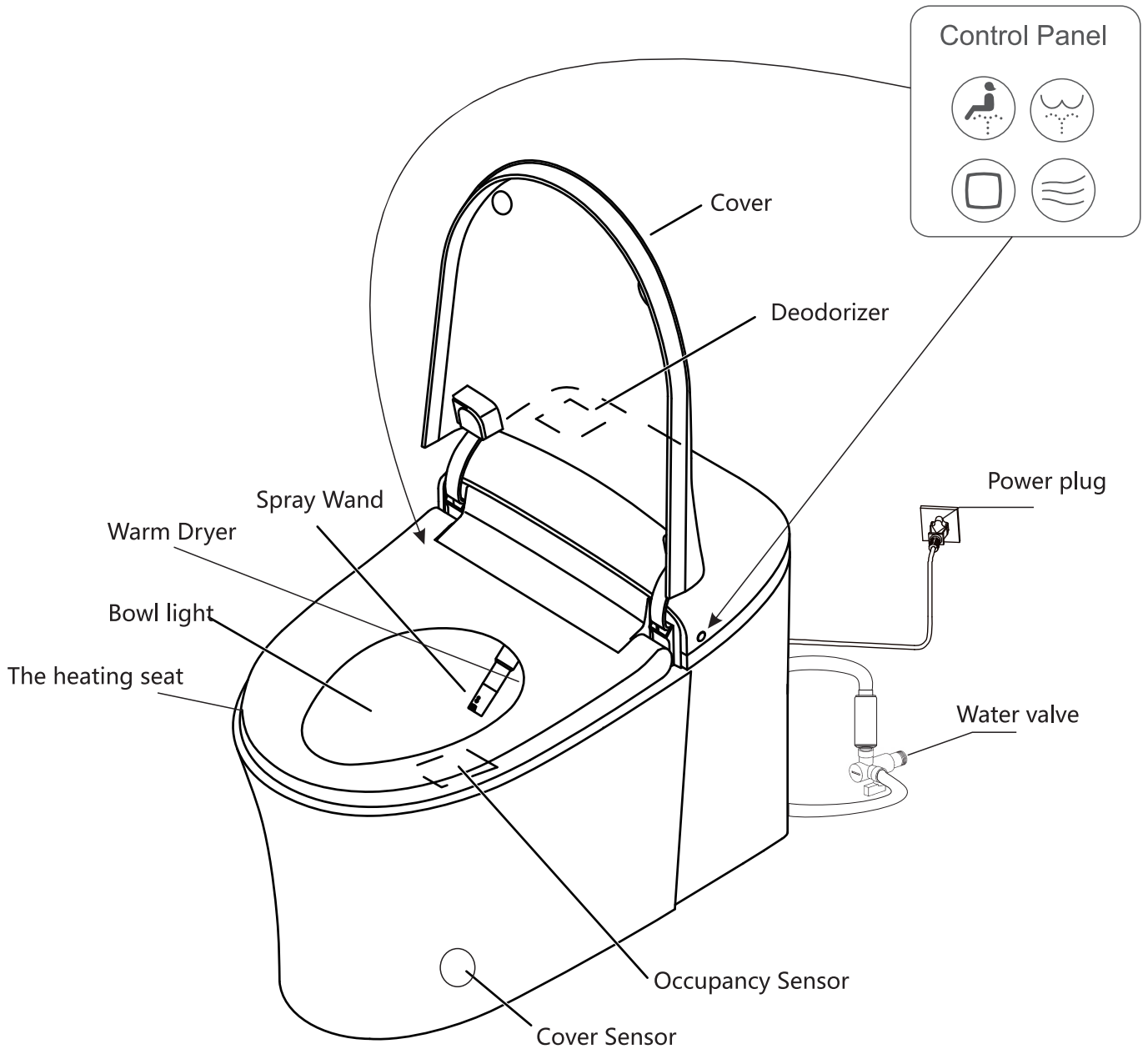

Operation Options

- Remote Control** - When paired with the toilet, the remote control operates the toilet features. Refer to the “Remote Control Setup” section for more information.
- Control Knob/Control Panel** - Located on the side of the toilet, the control panel allows easy access to primary toilet features.

Flush Options

- Users press the knob/button on the control panel, it uses 1.28gal(4.8L) of water per flush.**
- Automatic Flush** - When enabled, this feature automatically flushes the toilet after the user stands up, or approximately 3 minutes after the front of the toilet last radar sense motion.
- Foot Sense/Foot Touch**- When enabled, it flushes when the user’s foot moving close to the sensor or the user’s foot kick the button.

Seat and Cover

- Cover Sensor** - When the cover auto open/close feature is enabled, a motion sensor on the front of the toilet automatically opens the cover. The motion sensor range can be set to near, medium, or far. Sensor range may vary depending on your bathroom layout. For BR30018TAST9W
- Occupancy Sensor** - The sensor area is located on the front right side of the seat, and detects a seated user. The cleansing features will not function without a seated user.
- Heated Seat** - When activated, the seat features an adjustable heating option that will keep the seat warm.
- Energy Save** - When enabled, the toilet conserves energy by reducing the heated seat temperature when the toilet is not in use.

Wash Features

- Front/Rear/360°Rotary Wash** - Front, rear and 360°rotary wash, feature adjustable positioning, adjustable water temperature, adjustable water pressure, and pulsate and oscillate water action.
- Dryer** - The dryer features adjustable air temperature.

Lighting

- Nightlight** - The bowl light automatically illuminates when the light sensor detects low light conditions.

Cleaning

- Deodorizer** - Contains a replaceable cartridge. Refer to the “Replacing the Deodorizer” section.
- Automatic Bowl Mist** - Spray mist pre-rinses the bowl before use.
- Automatic Wand Rinse** - The spray wand is rinsed with water before and after each use.
- Automatic Wand Cleaning** - The spray wand is cleaned daily with UV light.
- Cleaning Mode** - Temporarily disables automatic flush and extends the spray wand to allow manual cleaning of the toilet and wand.

Remote control

Operation is subject to the following two conditions:

- (1) this device may not cause harmful interference.
- (2) this device must accept any interference received, including interference that may cause undesired operation

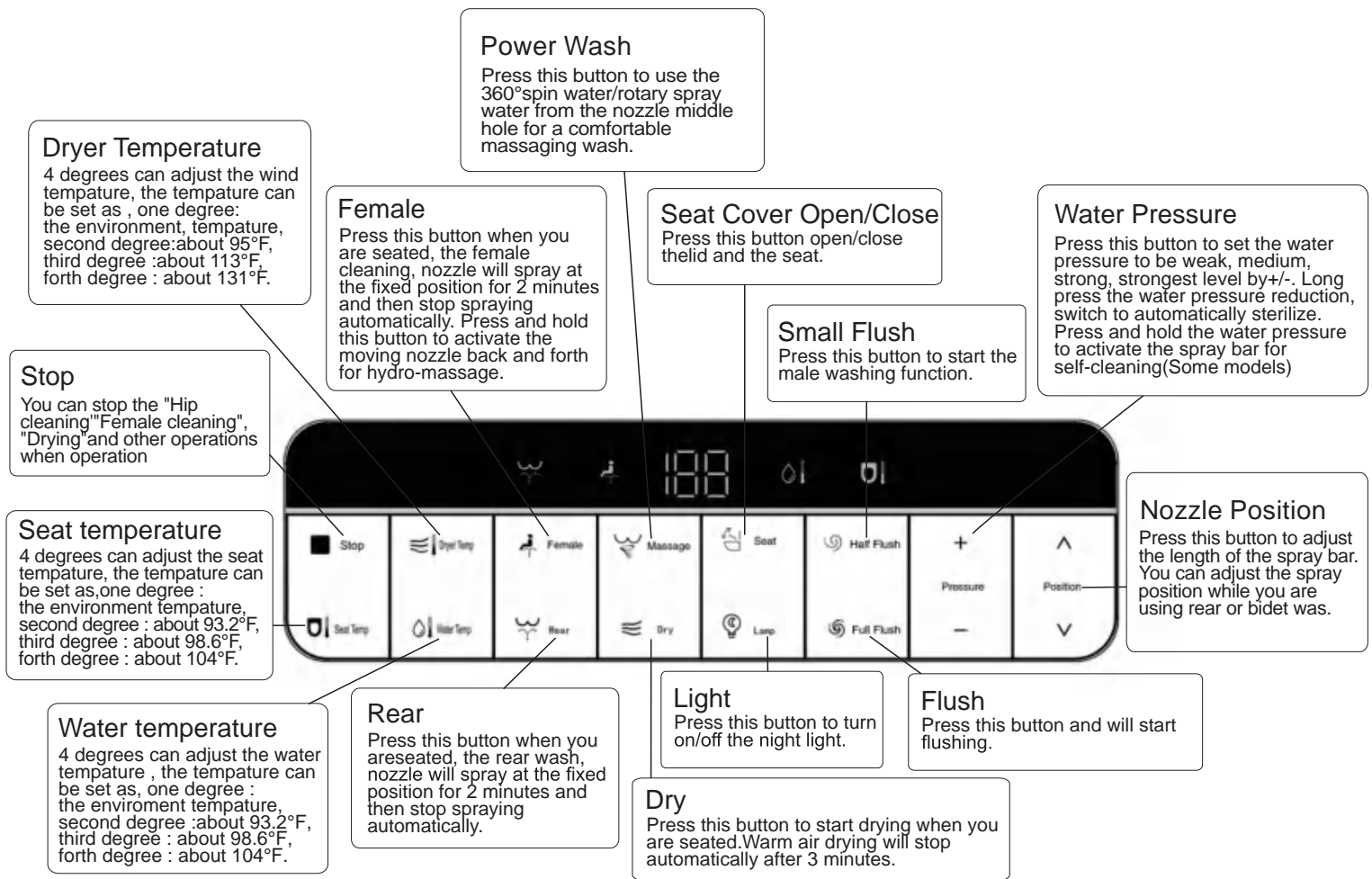

Auto flush

When the seat sensor no longer detects a user for 3 minutes, it will automatically close the cover and flush.

The toilet will only flush once.

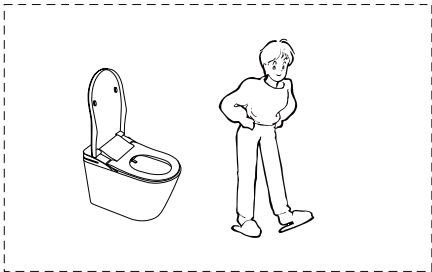

Emergency flushing

When the product is not powered-on , short press the rotated switch button on the side of the product or slightly touch the “Foot touch” button . It can achieve emergency flushing function.

*If the above operation does not work , you need to replace the battery or contact your local dealer.

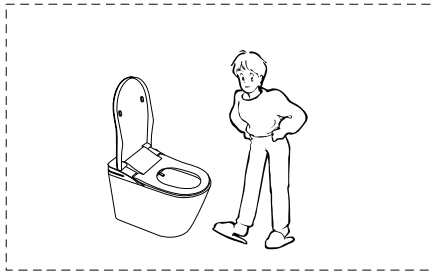

Dryer flush

Press the “Dryer”button

The warm air function is activated and a flush is performed.

*Rear / front wash is not available during flushing.

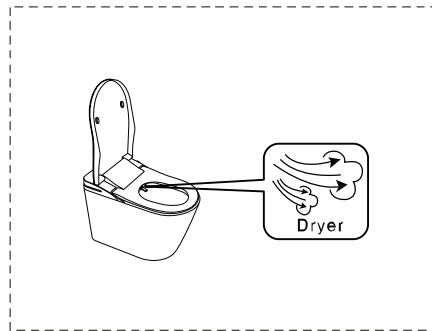

Kick flush

Tap the “Kick button” with your foot for easy , manual flushing.

Note that the “kick flush”function is available when user is sitting on the toilet seat .

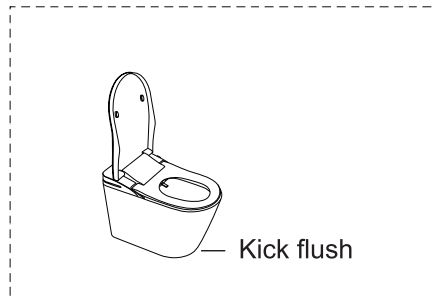

■ Radar induction for BR30018TAST9W

Radar will detect any user within a 3ft radius.

Lid will open automatically for any user within a 3ft radius.
Close automatically when it no longer detects a user.



■ Kick to open lid / seat for BR30018TAST9W

Tap the “Kick Button” with your foot to raise your toilet lid / seat.

Tap the kick button once: Lid opens.

Tap the kick button twice: Seat raises.

Tap the kick button three times: Seat and Lid will close and toilet will flush.

*Please do not touch the button forcefully.

*Rear / front wash is not available during flushing.

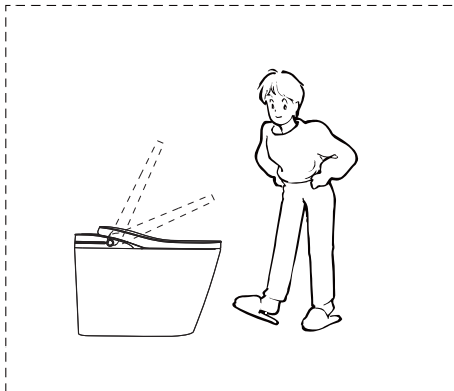

Smart Toilet

User-friendly Design

- **Slow-closing lid /seat**
Preserve your toilet's life and allow you to close the lid /seat silently .
- **Water purification**
Equipped with dedicated filter to ensure your bidet will only spray clean, filtered water.
- **Damper**
The product has installed the damper which provide the toilet cover and toilet seat with a buffer function, to achieve the mute effect.
- **8 Layers of safety**
8 different built-in safety features to protect the user and product.
- **Memory mode**
After power failure, water temp, water pressure, seat temp, and wand position are all restored to mid-range after power failure. Night light is turned on by default after power failure. On / off, keep the last memorized setting state.
- **Self-cleaning Nozzle**
The washer can automatically clean, keeping bacteria and stains away.
- **Pre-flush**
After seating, the product will flush once towards the seat to ensure that the seat wall is moistened.
- **Antibacterial Seat**
Antibacterial material is used for the seat.

Smart Toilet Maintenance

Regular maintenance is required to ensure normal use

Note

- Cut off the power and water supply before maintenance
- Direct water wash to the entire products is prohibited

Maintenance of product surface and ceramics

- Wipe dust or stains with a soft wet cloth
- A wet soft brush, cloth or sponge may be used to clean the ceramic area

*Do not use abrasive cleaning solutions, such as alcohol, bleach, paint thinner, cresol, benzene, gasoline, etc.



⚠ Warning

This product needs to be properly grounded
 *Risk of electric shock
 *If unsure , contact an electrician of Electrical installation company





Do not use a power socket in poor condition or a damaged power plug
 *Risk of fire and /or electric shock



Do not place a lit cigarette along with other burning abjects into the unit.
 *Risk of fire



Do not use during thunderstorms (pull out the power plug during storms). Failure in doing so may lead to injury or fault in the product

Do not touch ,insert or pull out the power plug with a wet hand .
 *Risk of electric shock

When the seat ring or the cover plate is damaged , to avoid any harm, be sure to pull off the power plug , close the water source and contact your local distributor for replacement
 *Risk of fire or electric shock

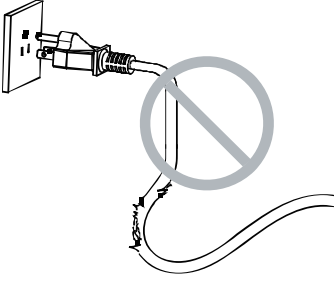

The power socket in use should be within the specified range (AC120V).
 *Risk of fire and/or electric shock

Periodically unplug the power plug and wipe off any dust from the power plug with a clean, dry cloth.
 *Fire risk

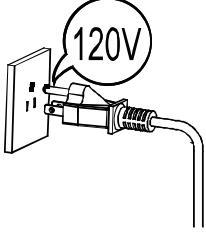

Any person with a disability , the elderly , and children , should be using this product with the supervision of another individual. Be advised that sitting on the heated seat for an extended amount of time may result in burns



Do not pull , damage , bend , twist , stretch,roll,bundle ,clamp or squeeze the power cable .Do not place anything on power cable
 *Risk of fire and /or electric shock



This product is not a toy , advise children not to play with product.
 *Risk of injury



If the power cord is damaged , to prevent any injuries or accidents , it should be replaced by a professional .
 *Risk of fire and /or electric shock



Do not dismantle , repair or alter this product on your own .Call in a professional , or contact Dyconn Faucet for further advice .
 *Risk of fire , eletric shock, and/or other accident that may lead to injury.



Warnings and Safety

Please read thoroughly

First of all, thank you for purchasing our product. To ensure proper and safe use of this product, carefully read this section prior to any usage.

Afterwards, store this manual in a safe place for any needed future reference.

The hazards and warnings listed herein are important to our user's safety.











Significant consequences may result from failure to heed warnings.

The company will not be held liable for any injuries to the user and damages to the product due to improper usage and/or failure to heed safety warnings.

Explanation of Terms and Symbols

Warning--Indicates possible injury resulting from improper usage due to negligence of this sign.

Attention--Indicates human injury or property loss that may result in improper usage due to negligence of this sign.

-  Note: When used with the above "Warning" and "Attention" signs, indicates a strict request to follow noted precautions
-  Prohibits any individual from performing any action with this symbol
-  Prohibits any individual from dismantling product
-  Keep product away from any wet environments, including but is not limited to, humid environments, close proximities to baths, showers or sinks
-  Do not touch!
-  Do not touch with a wet hand !
-  Keep away from any extreme heat or fire
-  Operate only as instructed
-  Pull out the power plug !
-  Protective grounding

⚠ Warning

For cleaning or maintenance of plastic parts , do not use any harsh cleaning agents .(These include ,but are not limited to products such as :concentrated sulfuric acid , concentrated nitric acid , glacial acetic acid,carbon tetrachloride, chloroform,acetone ,butanone, benzene , methylbenzene,phenol , methylphenol, dimethylformamide,methyl ether, soybean oil, acetate, 40% nitric acid ,thick salt acid ,95% alcohol, gasoline, kerosene or brake oil, etc. *Risk of damaging parts that can lead to accidents and injuries



Do not use polluted water or water meant for industrial .
 *Risk of urocystitis or dermatitis
 *Untreated water may also cause corrode inner workings of unit and may cause electrical shock or a fire.



Do not apply any force to the unit' s seat and lid .Do not stand on the lid or open or close the lid and seat forcefully .
 *This may result in product damage and/or user injury .



Do not add water or detergent into the unit or on to the wireless remote. Do not soak the product with water or cleaner.
 ※Risk of fire and/or electric shock.



Do not place your hand or any other object into the dryer trap, and do not cover the dryer and dryer trap during product use
 *Risk of fire , electric shock , and /or other accident that may lead to user injury



Do not install product in a humid environment or a soak room .
 Do not spray or soak this product with any form of liquid to prevent any damage to the product.
 *Risk of fire and/or electric shock .



Do not spray urine at the dryer tarp.
 *Risk of electric shock



Read the following for proper battery usage

- Properly install the battery according to its correct polarity.
- Remove the battery during long periods without use.
- Replace the battery before it reaches the end of its usage . Failure to do so may result in interrupted control signals.
- Cover the battery with tape before disposal.

*This will prevent battery fluid leaks that may cause fire and/or other damages.



Warning

Place the battery out of children and infant reach
 *If battery is swallowed , contact a doctor immediately.
 If battery fluid leaks onto user , quickly rinse off area using water.
 If battery fluid gets into eyes , don not rub your eyes .Quickly rinse it with water and consult a doctor immediately.
 *May result in vision impairment or blindness.



When the battery is in use ,do not do the following operations
 Do not hold or store with metal objects (such as a necklace or a watch).
 Do not mix new and old batteries.
 Do not pull battery apart battery or throw it into water and/or fire .Battery fluids may cause a fire.



Attention

Do not use the heated seat or warm dryer temperature for an extended amount of time.
 *Extended use may result in burns



Avoid direct sunlight or heat.
 *Risk of product discoloration.



While using this product, make sure that the skin is in contact with the seat sensor area. Otherwise , product may not operate correctly . Children and smaller individuals may have trouble staying in contact with sensor area.

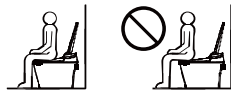

Do not supply electricity with an external switch. Le: connecting the universal part to a timer switch .
 *Run the risk of issues caused by improperly resetting the thermal breaker .



When the flter is being replaced, be sure to close the water supply angle valve. When the flter is being installed, be sure to fasten it with force.
 *Risk of water leak



Do not spray urine in the direction of the bidet nozzle.
 *Doing so may result in blockage to the bidet nozzles and cleaning area.



Pull out the power plug when the product is in disuse for an extended amount of time .Make sure to shut off the water and remove the water inside the product.
 *Risk of fire , leaks ,and product damage .



Do not use your old hose component. Use the one provided with your product. Anything else connected to the older hose may need to be replaced.
 *Risk of water leakage and /or property loss / damage.



In case of sudden power failure , remove the power plug and close the angle valve to prevent water leakage
 *Risk of water leakage and/or property loss / damage.



When storing or transporting in cold climate, make sure to remove all water from the unit. Product may crack and other damages may occur due to freezing water.
 *Risk of fire , leaks,and product damage .



WARNING

Do not spray water or detergents on the toilet, remote control or the power cord. Doing so may cause electric shock or fire.

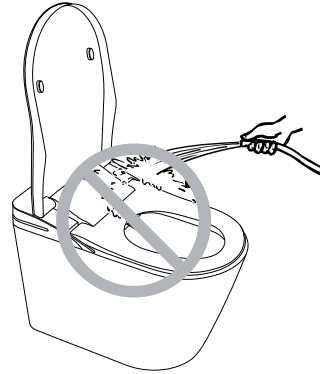

■ Maintenance during Winter Season

The water inside may freeze after long periods of storage and non-usage. Please take measures to prevent.

Note

- Before connecting the product to the water supply and electrical outlet, allow it to defrost for 30 mins in a warm indoor environment.
- In cases of extreme cold/freezing/nozzle stuck in place, wrap the water input line with a warm towel. Never pour hot water or use a hot dryer directly on the toilet.

Troubleshooting

This troubleshooting guide is for general aid only or qualified electrician should correct any electrical problems. For warranty service, contact your dealer or wholesale distributor, or contact the Customer Care Center using the information located in the front of this manual.

Start Up

When electrical power is connected to the toilet, the toilet will automatically go through a start-up sequence. The sequence includes wand movement, water line purge, and nightlight blinks. The toilet will go silent when the start-up sequence is complete.

If the toilet does not function correctly upon completing the start-up sequence, or fails to start, contact the Customer Care Center using the information located in the front of this manual.

Small Children

The automatic flush and cleansing features are activated by a sensor located inside the seat. Small children may not be tall enough to be detected by the sensor.

Power Troubleshooting

Symptoms	Probable Cause	Recommended Action
1.The toilet has no power.	<p>A.The power is not turned ON.</p> <p>B. The power cord is unplugged from the electrical outlet.</p> <p>C. The Ground-Fault Circuit-Interrupter (GFCI) or Residual Current Device (RCD) is tripped.</p> <p>D.The toilet is in standby mode.</p>	<p>A.Remove the right side panel and turn ON the internal power switch.</p> <p>B. Plug the power cord into a GFCI or RCD electrical outlet.</p> <p>C. Reset the GFCI or RCD.</p> <p>D.Press any icon on the side control panel to reactivate the toilet.</p>
2.The toilet beeps when electrical power is connected or disconnected.	<p>A.The toilet beeps during the start-up sequence and when powering down.</p>	<p>A.Normal operation. No action needed.</p>
3.The toilet does not respond.	<p>A.Electrical power to the toilet was briefly interrupted.</p>	<p>A.Turn OFF the electrical power to the toilet and wait until the power-down beeps stop. Then restore the power to the toilet.</p>
4.The nightlight does not turn ON in low light conditions.	<p>A.The nightlight is not enabled.</p> <p>B. The low light sensor lens is dirty.</p>	<p>A.Enable the nightlight. Refer to the “Enable/Disable Automatic Features” section.</p> <p>B. Clean the light sensor lens on the side of the toilet near the control panel.</p>

Flush Troubleshooting

Symptoms	Probable Cause	Recommended Action
1.The toilet does not flush.	<p>A.The water supply to the toilet is not turned ON.</p> <p>B. The toilet is blocked.</p> <p>C.The remote control is not working.</p>	<p>A.Turn ON the water supply.</p> <p>B. Use a plunger to remove the blockage. For extreme blockage, a snake may be used.</p> <p>C.Refer to the “Remote Control Troubleshooting” section.</p>

Symptoms	Probable Cause	Recommended Action
2.The toilet does not flush automatically.	<p>A.The automatic flush feature is not enabled.</p> <p>B. The user is not detected by the sensor.</p>	<p>A.Activate automatic flush. Refer to the “Enable/Disable Automatic Features” section.</p> <p>B. Children may be too small to be detected by the sensor. Flush the toilet using the remote control.</p>
3.The toilet flushes unexpectedly.	<p>A.The automatic flush feature is enabled.</p>	<p>A.When automatic flush is enabled, the toilet will flush shortly after use. To disable automatic flush, refer to the “Enable/Disable Automatic Features” section.</p>
4.The toilet bowl contains little or no water.	<p>A.The water has evaporated during an extended period between uses.</p>	<p>A.Flush the toilet to refill the bowl.</p>

Seat and Cover Troubleshooting

Symptoms	Probable Cause	Recommended Action
1.The seat cover does not open automatically.	<p>A.The cover open/close feature is not enabled.</p> <p>B. The motion sensor is set at far distance.</p>	<p>A.Activate the cover open/close feature. Refer to the “Enable/Disable Automatic Features” section.</p> <p>B. Adjust the cover open/close sensor distance using the remote control.</p>
2.The seat cover opens unexpectedly.	<p>A.The motion sensor is set at short distance.</p>	<p>A.Adjust the cover open/close sensor distance using the remote control.</p>
3.The seat is not heated.	<p>A.The toilet is in Energy Save mode.</p> <p>B. The heated seat feature is not enabled.</p> <p>C.The temperature setting is too low.</p>	<p>A.The seat will heat when used. Refer to the “Enable/Disable Automatic Features” section.</p> <p>B. Activate the heated seat. Refer to the “Enable/Disable Automatic Features” section.</p> <p>C.Adjust the heated seat temperature using the remote control.</p>

Wash Troubleshooting

Symptoms	Probable Cause	Recommended Action
1.Low or no water flow from the spray wand.	<p>A.The water supply to the toilet is not turned ON.</p> <p>B. The water supply hose to the toilet is kinked or looped too tight.</p> <p>C. The sensor does not detect the user.</p> <p>D.The filter is blocked or damaged.</p>	<p>A.Turn ON the water supply to the seat.</p> <p>B. Remove the kink in the hose or make a wider loop.</p> <p>C. Small children may not be detected. Adjust the sitting position. The sensor may have difficulty with fabric or other objects. The sensor is designed to sense skin.</p> <p>D.Service the filter. Refer to the “Servicing the Filter” section.</p>
2.Water stops flowing from the spray wand unexpectedly.	<p>A.Front or rear wash automatically stops after several minutes.</p>	<p>A.Press the “Front” or “Rear” icon to restart washing.</p>

Symptoms	Probable Cause	Recommended Action
3.The spray wand moves erratically or fails to extend.	<p>A.The wash cycle was interrupted.</p> <p>B. The spray wand is not responding to the remote control.</p> <p>C. The user is not detected by the sensor.</p> <p>D.The seal protecting against waterflow into the seat is dry.</p> <p>E. The spray wand pauses briefly to get rinsed, then fully retracts.</p>	<p>A.Turn OFF the power button on the back of the toilet and wait 10 seconds. Turn ON the power.</p> <p>B. Turn OFF the power button on the back of the toilet and wait 10 seconds. Turn ON the power.</p> <p>C. Children may be too small to be detected by the sensor.</p> <p>D.Use the remote control to extend the spray wand. Clean the wand with liquid soap. Rinse the wand, then apply more liquid soap for lubrication. Retract the wand.</p> <p>E. Normal operation. No action required.</p>
4.The dryer is too hot.	<p>A.The air temperature is set too high.</p>	<p>A.Use the remote control to decrease the air temperature.</p>
5.The dryer does not start immediately.	<p>A.The spray wand has not finished retracting after the wash cycle completion.</p>	<p>A.There is a brief delay while the wand fully retracts, then extends again for the dryer cycle.</p>
6.The deodorizer is not working.	<p>A.The automatic deodorizer feature is not enabled.</p>	<p>A.Activate the automatic deodorizer feature. Refer to the “Enable/Disable Automatic Features” section.</p>
7.The toilet beeps while occupied.	<p>A.The seat has been occupied for an extended time.</p>	<p>A.Normal operation. No action required.</p>

Remote Control Troubleshooting

Symptoms	Probable Cause	Recommended Action
1.The remote control does not turn on.	<p>A.The batteries are not properly installed.</p> <p>B. The batteries need to be replaced.</p>	<p>A.Reinstall the batteries. Refer to the “Replacing the Batteries” section.</p> <p>B. Replace the batteries. Refer to the “Replacing the Batteries” section.</p>
2.The remote control does not connect to the toilet.	<p>A.The remote control is too far from the toilet to receive a signal.</p> <p>B. The remote control is not paired with the toilet.</p>	<p>A.Move the remote control closer to the toilet to regain a connection.</p> <p>B. Pair the remote control to the toilet. Refer to the “Remote Control Setup” section.</p>



Model: BR30018TAST9W

Phone: 888-257-3857

Website: www.casainc.com

Customer Service: service@casainc.com