

INSTRUCTION

SMART TOILET

Concealed cistern series

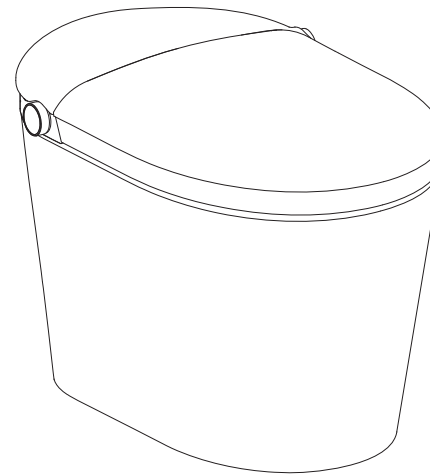

- Thank you for purchasing our product.
Before using, please read the instruction carefully.
Please keep the instruction properly for further reference.
- Our company reserves the right of final interpretation for this manual. The manual is subject to change without notice.

Catalogue

Packing List	02
Installation of the Battery Box	03
Packing List	04
Components	05
Technical Drawing	06
Features	06
Attentions	08
Installation Instruction	15
Preparation before Use	21
Panel Instruction	22
How to Use	24
Function Setting and Adjustment	25
Cleaning and Maintenance	29
Troubleshooting	33
Function List	34
Product Specification	35
Acceptance Record	36

Packing List

Dear user,
Please count the following items after opening the package:

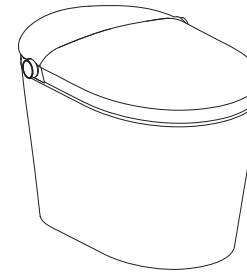

Smart Toilet

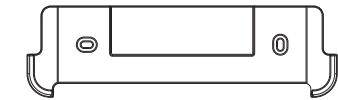

Remote Control & Mounting Bracket

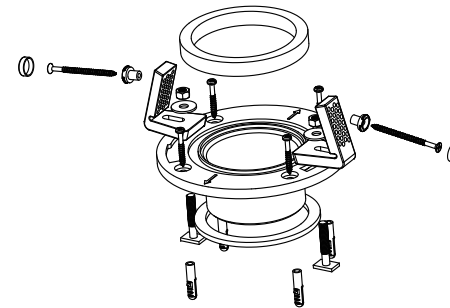

Flange, Sealing Wax Rings,
Mounting Accessory Kit

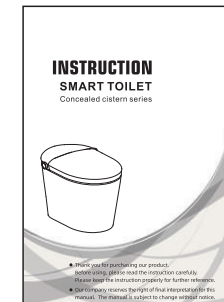

Instruction Manual

Battery Box for Power Outage Flush

Installation of the Battery Box for Power Outage

1. This battery box is for use as backup during power outages. **The battery box must not be used simultaneously with a plugged-in power source when the toilet is in operation.** It is recommended to connect it to the main unit only during power outages. We accept no responsibility for the consequences of using dual power sources at the same time, and such usage is not covered by the warranty.

2. **Before activating the power outage flushing function, install one 9V alkaline batteries into the battery box in advance (open the battery box with a screwdriver). Do not mix new and old batteries, batteries of different models, or batteries from different brands. When replacing the batteries, ensure that all are replaced at the same time.**

3. Please follow the "+" and "-" signs on the battery box when installing batteries. This battery box is a series battery group, and no single cell can be reversed. Failing to do so may cause battery damage, and in severe cases, may pose safety hazards such as explosion and combustion.

4. Take out the battery connection cable from the rear side of seat cover and connect it to the battery box, ensuring that it is plugged in place.

5. Do not disassemble the battery box unnecessarily. After replacing the battery, make sure to seal the battery box tightly. If moisture from the bathroom gets into the box, it could cause the batteries to rust and become damaged.

6. When replacing batteries, disconnect the battery box from the main unit.

7. To avoid potential hazards, this battery box cannot be recharged.

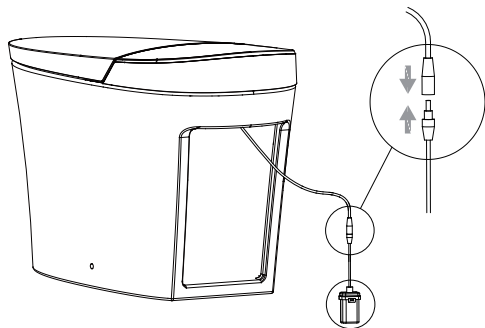

Packing List

Dear user,

Please count the following items after opening the package:

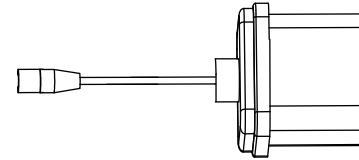

Backup Battery Box
for Power Outage Flush

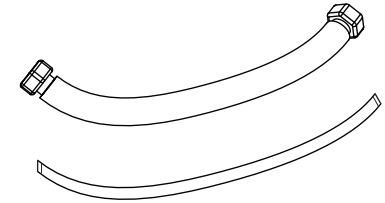

1 Braided Hose (for Flushing Water)
1 Plastic Hose (for Cleansing Water)
(Pre-installed)

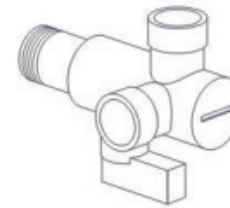

Valve

Components

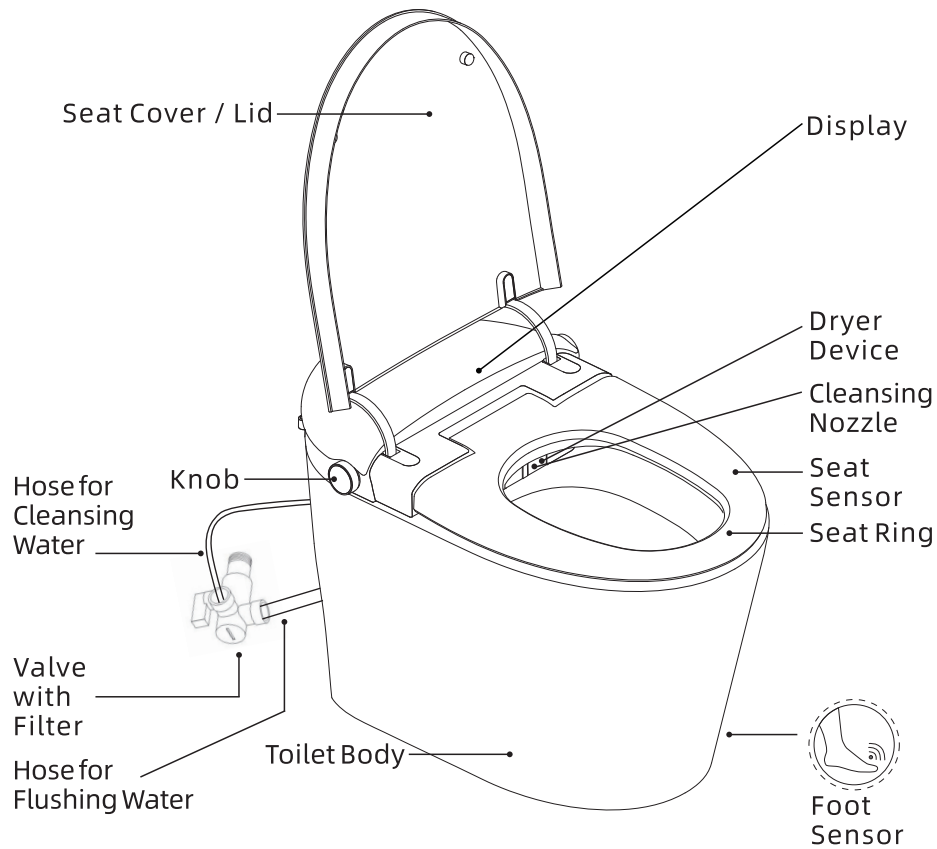

Remote Control



Technical Drawing

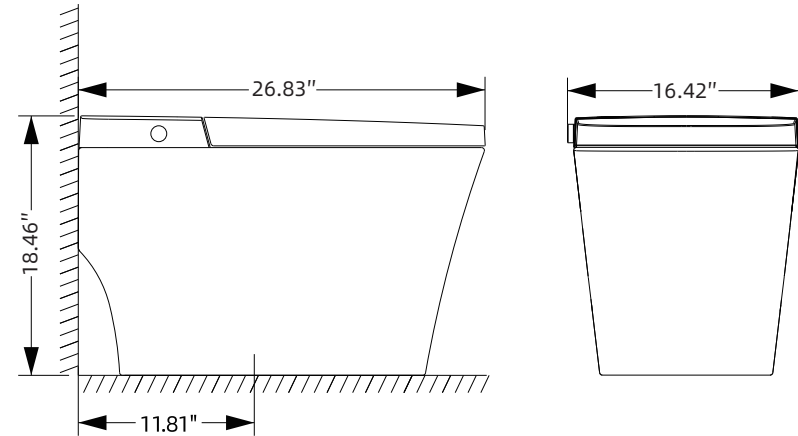

Features

Remark: The below features/functions can also be activated and adjusted by the wireless remote control, details will be listed in the later part of this manual.

Foot Sensor to Open / Close the Lid / the Seat Ring

Open / close the lid or the seat ring when user lifts their foot around the sensor.

Aperient

Water comes from the single-hole of the nozzle with strongest level of pressure to assist with bowel movements.

Rear Cleansing

Water comes from the single-hole of the nozzle, powerful cleansing.

Rear Cleansing with Nozzle Oscillation

The nozzle moves back and forth to wash with wide range.

Front Cleansing

Water comes from the nozzle hole designed for female use, gentle cleansing.

Front Cleansing with Nozzle Oscillation

The nozzle moves back and forth to wash with wide range.

Features

Cleansing Strength Adjustment

Adjust the cleansing strength/water pressure according to your preference.

Cleansing Position Adjustment

Adjust the cleansing position by moving the nozzle forward and backward.

Cleansing Water Temperature Adjustment

4 levels of cleansing water temperature adjustment: normal (room temperature) / low / medium / high.

Warm Air Dryer

Warm air dryer with 4-level temperature control (room temperature / low / medium / high), drying after cleansing.

Seat Sensor

All corresponding functions will be activated and be ready after seated.

Seat Ring Temperature Adjustment

Heated seat with 4 levels of temperature adjustment: normal (room temperature) / low / medium / high.

Remote Control

All functions can be accessible by the wireless remote control.

Off Seat Auto Flush

Auto flush after using and standing up from the bidet toilet seat.

Foot Sensor Flush

Flush by lifting the foot near the sensor.

Flush by Remote Control

Flush by pressing the flush button on the remote control.

Flush by Side Knob

Flush by pressing the side knob on the smart toilet.

Night Light

The night light is designed to be gentle on the eyes and provide enough illumination to navigate the bathroom without needing to turn on any harsh overhead lights.

Nozzle Cleaning

Long press the corresponding button on the remote control when unseated, the nozzle will enter the self cleaning mode. Easy for daily maintenance.

Nozzle Auto Cleaning

Nozzle will auto clean itself before and after using.

Power Outage Flush

Equipped with a backup battery box, the backup battery can be activated for flushing when there is a power outage.

Attentions



WARNING



NO WATER

Do not pull the plug with wet hand.

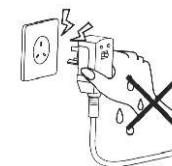

▲Otherwise, it may cause electric shock.



PROHIBIT

Do not pour water, detergent or deodorant on the smart toilet main unit and power plug. Otherwise:

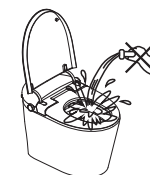

▲It may cause fire, electric shock, short circuit or damage.

▲Injury or indoor water seepage may occur due to product damage.



PROHIBIT

When there is thunder, do not touch the power plug.

▲Otherwise, it may cause electric shock.



PROHIBIT

Do not touch the water inlet hose to the power plug or outlet.

▲Otherwise, it may cause fire, electric shock, heating, or short circuit due to condensation.



PROHIBIT

Do not damage the power cord or plug. Do not forcefully drop, pull, twist, bend, scratch, process, heat, place heavy objects on, tie, or clamp the power cord or plug.

▲Otherwise, it may cause product damage. Continuing to use the product in a damaged state may cause fire, electric shock, heating, or short circuit.



Do not use power outlets that are loose or malfunctioning.

▲Otherwise, it may cause fire or short circuit.

PROHIBIT



Please use power outlets and wiring tools within the specified range.

▲When the wiring exceeds the specified range of the outlet, it may cause fire due to overheating.

PROHIBIT



Do not use a power source other than the specified one (AC110V, 60Hz). Please do not plug in until the inlet valve opens.

PROHIBIT

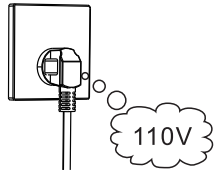

▲Otherwise, it may cause fire.



Do not disassemble, repair, or modify this product on your own.

▲Otherwise, it may cause fire, electric shock, heating, short circuit or damage.

NO DISASSEMBLE



Do not install on a moving vehicle, ship, or other mobile structure. Otherwise:

▲It may cause fire, electric shock, short circuit, or malfunction.

PROHIBIT

▲The seat ring, seat cover, and smart toilet main unit may be damaged due to detachment and falling.



When the smart toilet malfunctions, do not continue to use it. In the following situations, turn off the power and close the water inlet valve to stop the water supply.

PROHIBIT

*Water leaks from the hose or product inside to the outside.

*The product has cracks or damage.

*Abnormal sound or odor.

*Product smoking.

*Product abnormal heating.

*The cushion of the seat ring falls off.

▲Continuing to use the product in a malfunctioning state may cause fire, electric shock, heating, short circuit, injury, or indoor water seepage.



Do not use water sources other than tap water or potable well water (groundwater). Otherwise:

PROHIBIT

▲It may cause corrosion in components or machine malfunctions.

▲It may cause skin inflammation or burns due to unclean water.



Do not put your fingers or other objects into or block the warm air outlet, and do not place or cover objects or clothing on the warm air outlet.

PROHIBIT

▲Otherwise, it may cause burn, electric shock, or burning of accessories.



Beware of low-temperature burns.

MANDATORY

▲Improper use of the warm seat ring may result in low-temperature burns.

▲If sitting on the seat ring for a long time, please set the temperature of the seat ring to normal/unheated (room temperature).

▲When using the warm seat ring or warm air drying function, please set the temperature of the seat ring to normal/unheated (room temperature) and the temperature of the warm air dryer to the lowest setting for the following groups of people.

* Children, the elderly, and those who are unable to adjust the temperature to a suitable level themselves.

* Individuals with behavioral impairments such as patients or people with disabilities.

* Individuals who have taken hypnotic drugs (such as sleeping pills, cold medicine, etc.), heavy drinkers, and those who are excessively fatigued must use this product under the supervision of a responsible person.



Please confirm that the power outlet has been waterproofed.

MANDATORY

▲Make sure of the position of the outlet before installation and keep it away from the bathtub as much as possible.

▲If it is not waterproofed, it may cause fire or electric shock.

▲For the installation and waterproofing of the outlet, please consult qualified professionals.



Please confirm that the outlet being used is correctly grounded.

MANDATORY

▲Otherwise, it may cause electric shock due to malfunction or short circuit.

▲When installing the ground wire, please entrust a professional installation company.



Do not pull out the power plug by holding the power cord. When unplugging the power plug, do not hold the power cord, but hold the power plug.

MANDATORY

▲Otherwise, it may cause fire or heating due to damage to the power cord.



Please make sure to firmly insert the power plug into the outlet.

MANDATORY

▲Otherwise, it may cause fire, heating, or short circuit.



If the power cord is damaged, it must be replaced by the manufacturer, maintenance department, or other professionals to avoid potential hazards.

MANDATORY



When performing maintenance (not include the nozzle cleaning function), be sure to turn off the power.

MANDATORY

▲Otherwise, it may cause electric shock.



This is an electrical product. Do not install it in places where it is easy to be splashed with water or where the humidity is high. When using it in the bathroom, please install an exhaust fan or ventilation opening to keep the bathroom well ventilated.

MANDATORY

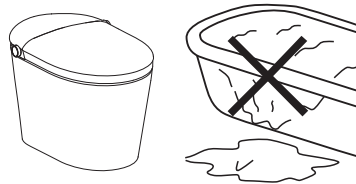

▲Otherwise, it may cause fire or electric shock.



When removing the smart toilet main unit, be sure to disconnect the power.

MANDATORY

▲Otherwise, it may cause fire or electric shock.



Individuals with physical, sensory, or cognitive disabilities, or those lacking experience and knowledge of this product (including children), must use this product under the supervision of a responsible person. Children should not play with this product.

MANDATORY

▲Otherwise, it may cause burn, electric shock, fire, or injury.



NO BURNING

Do not let cigarettes or other sources of fire get close to the product.

▲Otherwise, it may cause fire.



PROHIBIT

When maintaining plastic parts (seat ring, seat cover, etc.) and water inlet hoses, please use kitchen detergent (neutral). Do not use the following items: toilet cleaner, household detergent, gasoline, benzene, washing powder, or nylon brushes. Otherwise:

▲It may damage plastic parts, causing cracks and resulting in personal injury or malfunction.

▲It may damage the water inlet hose and cause water leakage.



PROHIBIT

Do not forcibly impact the product. Do not place heavy objects on or stand on the seat ring, seat cover, or smart toilet main unit. Otherwise:

▲The product may crack, and the smart toilet main unit may detach and fall, causing personal injury.

▲Injury or indoor water seepage may occur due to product damage.



PROHIBIT

Do not use the smart toilet when its main unit is loose.

▲Otherwise, the smart toilet main unit may detach and fall, causing personal injury.



PROHIBIT

Do not use your hands to lift the smart toilet main unit by holding the seat ring or seat cover. Do not open the seat ring or seat cover when there are items on them.

▲Otherwise, the smart toilet main unit may detach and fall, causing personal injury.



PROHIBIT

Do not violently open or close the seat cover or seat ring, or swing the seat cover and seat ring quickly. Otherwise:

▲The flipping device may fail due to the powerful external force.

▲The main unit may break or detach from the toilet body due to powerful external force, causing personal injury.



PROHIBIT

Do not bend or damage the water inlet hose.

▲Otherwise, it may cause water leakage.



To prevent sudden water leakage, do not remove the filter in the t-valve when the shut-off valve is open.

PROHIBIT

- ▲Otherwise, water may spray out.
- ▲Please refer to the cleaning method for the water inlet filter described on page 33.



Please use the new hose component provided with the product. The old hose cannot be reused.

PROHIBIT

- ▲Using the old hose component may result in water leakage or hose rupture.



When water leaks, be sure to turn off the shut-off valve.

MANDATORY



In order to prevent pipes or hoses from being damaged due to freezing, anti-freezing measures should be taken.

MANDATORY

- ▲When the water inlet hose is frozen, it may damage the main unit of the smart toilet or the pipe and cause water leakage.
- ▲If the room temperature is below 32°F/0°C, it is recommended to empty the water inside the product to prevent internal cracking due to freezing.



When the smart toilet is not used for a long time, be sure to drain the water from the smart toilet main unit and water inlet hose, and disconnect the power supply. When using it again, please first let the water flow through, and then use it. Otherwise:

MANDATORY

- ▲It may cause skin inflammation due to water deterioration.
- ▲If the power is always turned on, it may cause fire or heating.



When installing the water inlet filter, make sure to tighten it firmly to the correct position.

MANDATORY

- ▲Otherwise, it may cause water leakage.



Do not use any paper other than toilet paper, and do not drop objects that may clog the drain into the toilet bowl.

MANDATORY

- ▲Otherwise, it may cause blockages in the ceramic pipes of the toilet.



Do not operate the remote control with wet hands, and do not spill water on the remote control.

PROHIBIT

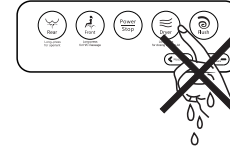

- ▲Otherwise, it may cause remote control malfunctions.



Do not put any solid substances or corrosive liquids into the water tank.

PROHIBIT

- ▲Otherwise, it may cause blockages or corrosion of the flushing water pipe.

Installation Instruction

■ Installation of the Smart Toilet

1. Confirmation of installation environment

Before installation, please confirm that the bathroom wall and floor tiles have been completed, and that the sewage pipes, water pipes, and electrical circuits have been reserved as shown in the figure below. This toilet rough-in is 300mm (11.81in); Water inlet pressure range: 0.15Mpa (dynamic) - 0.75Mpa (static); water inlet temperature: 4°C-35°C (39.2°F-95°F).

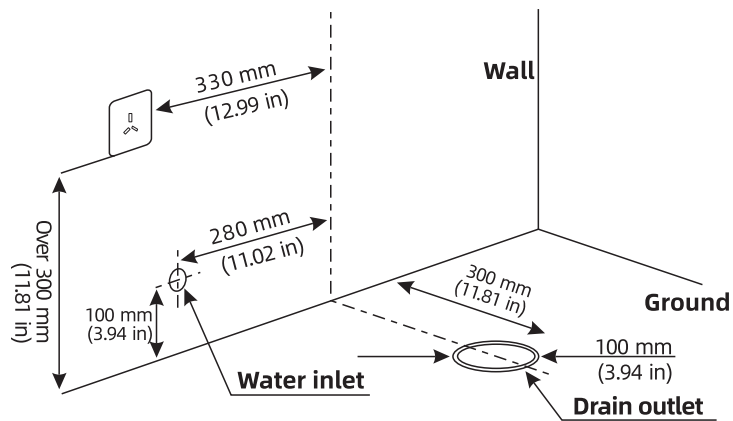

2. Assembly of dedicated valve

Install the valve provided with the product.

- Note: Remove the old water supply valve if it has been installed before.

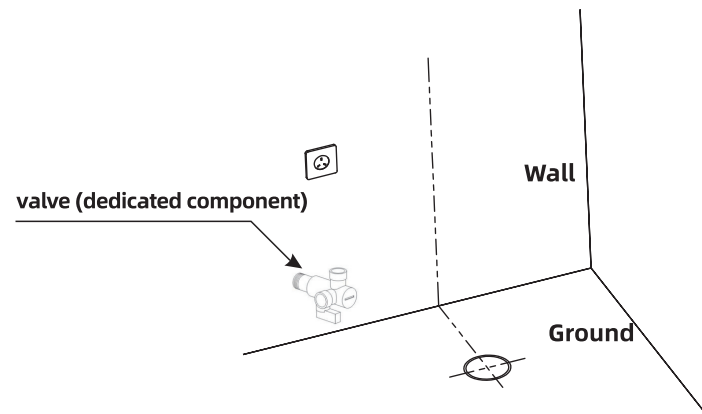

3. Installation and mounting of the toilet

(1.1) Assemble the mounting bracket with bolts and then secure them to the flange on the ground and tighten with nuts. **Please refer to Figure 1.0 on the next page for details.**

(1.2) Install the toilet on the corresponding position.

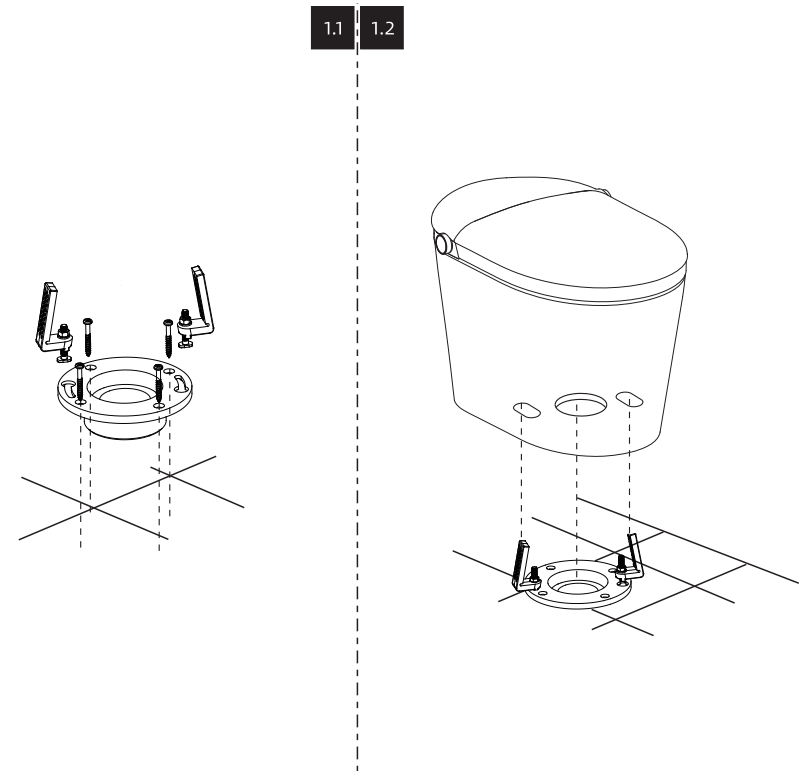

1.0

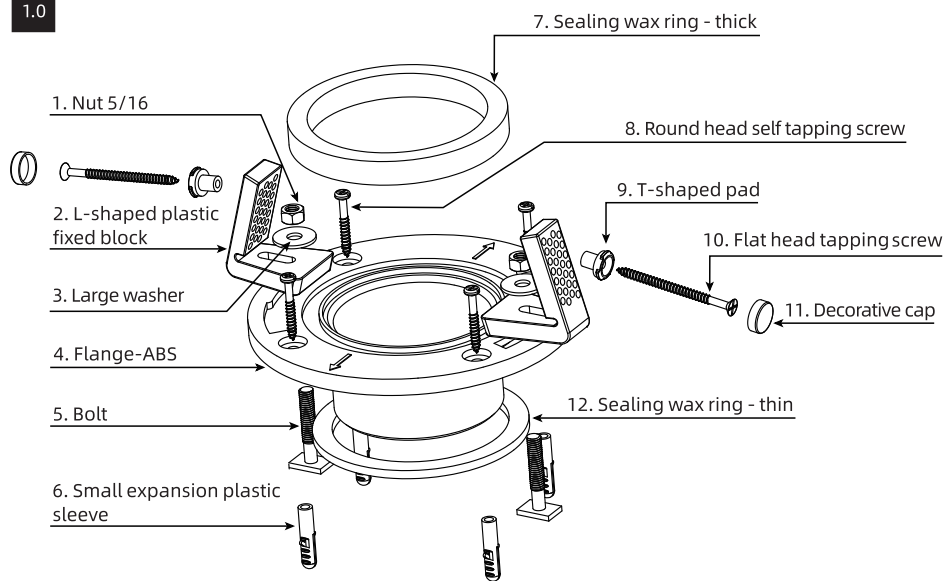

Flange accessories package

Details:

- 1. Nut 5/16 (2pcs)
- 2. L-shaped plastic fixed block (2pcs)
- 3. Large washer (2pcs)
- 4. Flange-ABS (1pc)
- 5. Bolt (2pcs)
- 6. Small expansion plastic sleeve (4pcs)
- 7. Sealing wax ring - thick (1pc)
- 8. Round head self tapping screw (4pcs)
- 9. T-shaped pad (2pcs)
- 10. Flat head tapping screw (2pcs)
- 11. Decorative cap (2pcs)
- 12. Sealing wax ring - thin (1pc)

Optional accessories

- 13. Outer hexagon self tapping screw (2pcs)
- 14. Small washer (2pcs)
- 15. Large expansion plastic sleeve (2 pcs)

Optional accessories

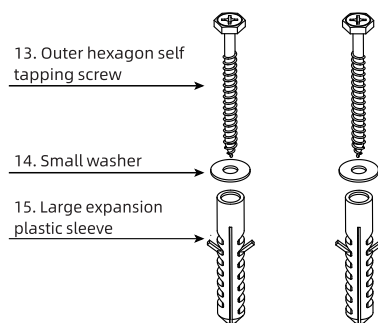

(2.1) Put the screw through the T-shaped pad and then install it through the holes (on both sides of the toilet ceramic) to the mounting bracket (L-shaped plastic fixed block) on the ground, and tighten it securely with a tool.

(2.2) Put the decorative cap on the T-shaped pad.

(2.3) Connect the water inlet hose and water pump with the water tank and tighten them with an adjustable wrench.

2.1

2.2

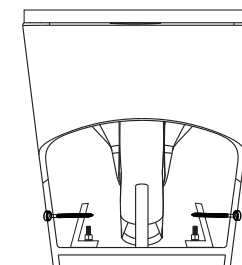
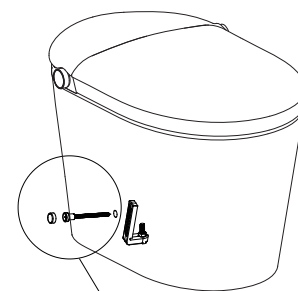

2.3

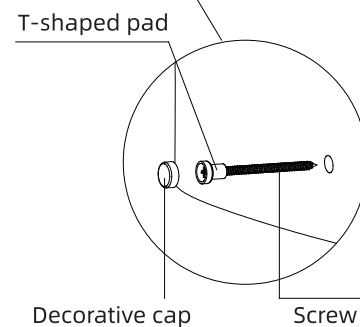

(3) Caulk the bottom of the toilet with silicone sealant.

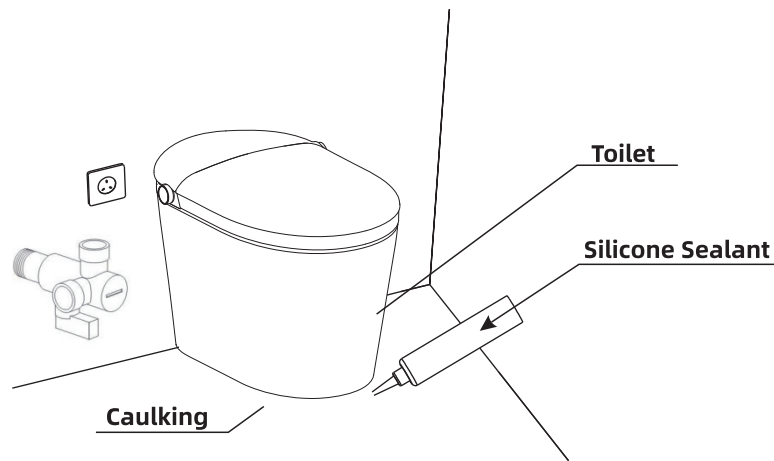

4. Connection of the water inlet hose

Connect the inlet hose with the valve by using tools like wrench.

- Notice: After installation, turn on the shut-off valve to check whether it leaks.

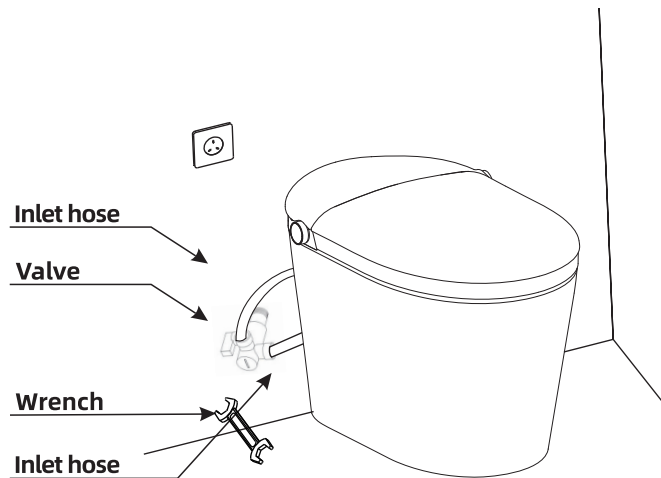

■ Installation of the Remote Control

1. Installation of remote control batteries.

Open the battery cover of the remote control and put two alkaline batteries (AAA) into the remote control one by one.

- When installing the batteries, do not reverse the positive and negative sides of the batteries.
- Do not use different or different types of batteries at the same time.
- Remove the batteries when it is not in use for a long time.

2. Confirm the installation location of the remote control.

Install the remote control in a suitable area where it is easy to get or operate when user sit on the smart toilet.

3. Install the remote control bracket on the wall.

Peel off the protective tape of 3M adhesive on the back of the bracket and apply to the selected dry tile surface.

4. Install the remote control.

Align the remote control with the bracket, insert it from top to bottom, and the installation is completed.

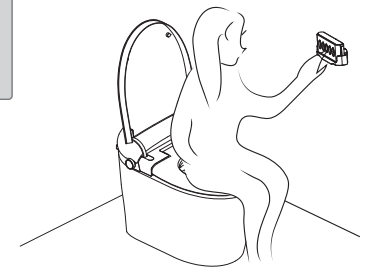
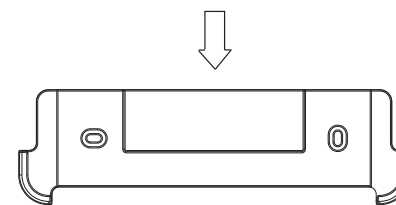

Preparation before Use

1. Open the valve

Turn the valve counterclockwise to fully open the water supply valve.

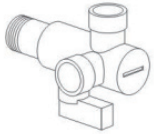

2. Plug the power plug into the outlet.

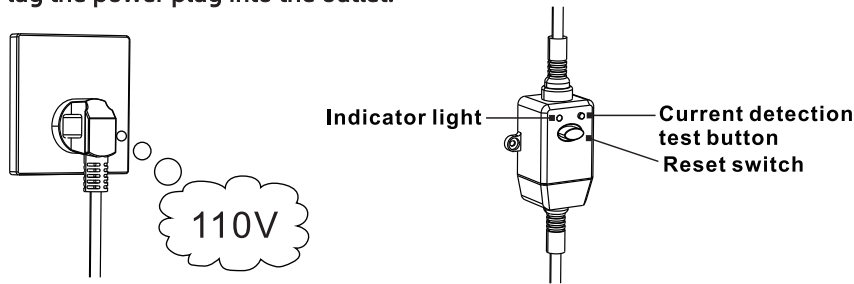

Power Connection Insert the leakage protection plug into a power socket, press the reset switch, plug indicator lights up, indicating that the power is on.

Note: Press the test button prior to usage, the reset switch pops up indicating that the leakage protection function is normal. Press the TEST button (then RESET button) every month to assure proper operation.

- *Only for models with leakage protection plug.
- *Please refer to the actual product.

Plug the power plug into a 110V power outlet. The smart toilet will perform a self-check run once, and the main unit will be in standby mode.

- When performing a self-check, the toilet will automatically open and close the lid/seat ring, and reset itself. It is forbidden to block it manually.
- Do not use wiring that exceeds the power supply specifications, such as an extension cord.
- The outlet must be reliably and safely grounded.

3. Adjust the cleansing water temperature and the seat temperature to the appropriate level.

4. Refer to Function Setting and Adjustment on Page 22 and use the remote control to operate various functions.

Panel Instruction

This product is designed primarily for remote control operation, with main unit panel operation as a supplement.

■ Remote Control Panel

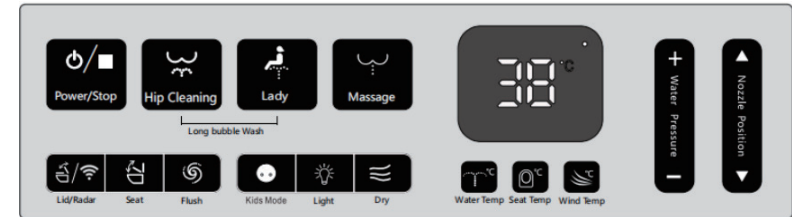

Applicable model: High configuration type

● Match the remote control

(Notice: After connecting the power, the bidet toilet seat will enter a self-test state. After 30 seconds, the knob indicator will stop flashing and the seat will transition to standby mode.)

If the remote control does not operate when batteries are installed, re-match the remote control to the bidet toilet seat. Rotate the knob toward the "Lady Wash" position for 3 seconds. At the same time, press the remote control's "Lid" button twice. You will hear a beep, indicating that the pairing was successful.

Note: The appearance and functions of the remote control may vary slightly for different models. Please refer to the actual product for details.

■ Function Side Knob (with Light Ring) on the Main Unit.

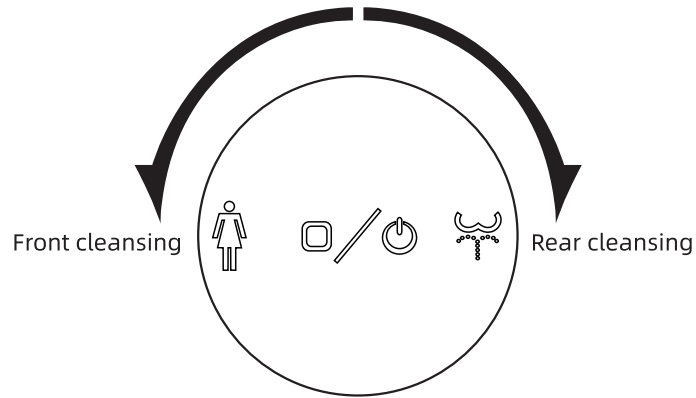

Switch by pressing the knob
Flush/Stop

- When in non-working condition (e.g. not cleansing or drying), press the knob down vertically to flush once.
- When in a seated position, rotate clockwise to activate the rear cleansing function; rotate counterclockwise to activate the front/female cleansing function; press down vertically to stop the running function (such as rear cleansing, female cleansing, drying).

Knob color

Bottom wash (blue)	Female wash (purple)	Drying (red)	Children's wash (blue)	Massage and defecation (blue)
Self-cleaning (yellow)	Seating (yellow)	Standby (colorful running water)	Seat temperature alarm (blue/flashing)	Water temperature alarm (red/flashing)

How to Use

■ When Sitting on the Seat Ring

- Upon hearing the "beep" sound, the various functions of the smart toilet will begin to start up.
- The nozzle will clean itself automatically.

■ Start Rear Cleansing or Front Cleansing Function

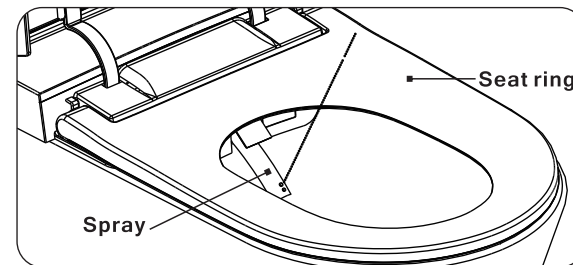

- Start the rear cleansing or front cleansing function by the remote control.
- Adjust the cleansing position and water pressure by the remote control.
- Start the drying function by the remote control.
- Press "stop" button to stop the bidet function (rear cleansing, front cleansing or drying)

■ When standing up from the seat

- The toilet will auto flush once.

Function Setting and Adjustment

■ Auto-Open The Seat Cover

When get close to the toilet, the lid will auto-open. Pressing the button of 3s  on remote control to turn on/off this function.

■ Lid/Seat Ring Open/Close

● The product has a foot sensing function for opening the toilet lid/seat ring. When user lifts their foot around the sensor, they can perform the lid/seat ring flipping operation.

In the unseated state:

- When the seat cover and seat ring are closed, lift your foot once around the sensor on the side of the toilet to flip the seat cover;
- When the seat cover is open and the seat ring is closed, lift your foot once around the sensor to flip the seat ring.
- When both the seat cover and seat ring are open, lift your foot once to close the seat cover and seat ring, and flush once (if the last operation performed was a flush, then it will not flush again this time).

● When the toilet is in rear cleansing, front cleansing, or drying mode, the lid/seat ring open/close function cannot be used.

■ Aperient

● The product has aperient function where cleansing water comes from the single-hole of the nozzle to assist with bowel movements. Pressing the button of  on remote control.



● In the seated state, press the button on the remote control with a following "beep" sound to start the aperient function. You can end it by pressing the "Stop" button on the remote control or pressing the side knob down vertically.

■ Kids Mode

● The cleaning process uses a default water temperature of 34°C (level 2), water pressure of level 1, and spray position of level 3.



■ Rear Cleansing

● This product has a rear cleansing bidet function by using a single-hole high-pressure cleaning nozzle.



- Press the button  on the remote control to enter the rear cleansing mode.
- In rear cleansing mode, press the button again to activate the oscillating cleansing function (the nozzle moves back and forth). Press the button again to deactivate the oscillating cleansing function (the nozzle stops moving). You can switch between these functions circularly.
- Rear cleansing will automatically turn off after approximately 90 seconds. You can switch to other functions or simply press the  button to deactivate it before the 90 seconds are up.
- The nozzle will automatically clean itself before and after rear cleansing.

■ Front Cleansing/Female Cleansing

● This product has a female cleansing function, with a dedicated nozzle hole for gentle cleansing.

- Press the button  on the remote control to activate the front cleansing mode.
- In front cleansing mode, press the button again to activate the oscillating cleansing function (the nozzle moves back and forth). Press the button again to deactivate the oscillating cleansing function (the nozzle stops moving). You can switch between these functions circularly.
- Front cleansing will automatically turn off after approximately 90 seconds. You can switch to other functions or simply press the  button to deactivate it before the 90 seconds are up.
- The nozzle will automatically clean itself before and after front cleansing.



■ Water Pressure Adjustment

- In rear cleansing or front cleansing mode, press the button  to adjust the water pressure strength according to your preference.
- 4 levels of water pressure are available. Press the button  to enter the adjustment mode and adjust it to your desired intensity.



■ Light strip switch

- While seated, press the button to control the light strip.



■ Nozzle Position Adjustment

- In rear cleansing or front cleansing mode, press the button  to move the nozzle back and forth and adjust the cleansing position to your liking.
- 4 levels of nozzle position are available. Press the button  to enter the adjustment mode and adjust it to your desired position.



■ Cleansing Water Temperature Adjustment

- Press the remote control button , and the main unit will respond with a "beep" sound prompt, entering the water temperature setting mode. Adjust the cleansing water temperature to the appropriate level.
- The water temperature can be adjusted to 4 different levels, including room temperature, high, medium, and low levels. Press the water temperature button  once to switch to another level.



■ Drying Function

- Press the remote control button , to activate the air dryer. By activating this function, the device will blow warm air onto the wet areas to dry them.
- Drying function will automatically turn off after approximately 3 minutes. You can switch to other functions or simply press the  button to deactivate it before the 3 minutes are up.

■ Air Dryer Temperature Adjustment

- Press the remote control button , and the main unit will respond with a "beep" sound prompt, entering the dryer temperature setting mode. Adjust the air dryer temperature to the appropriate level.
- The dryer temperature can be adjusted to 4 different levels, including room temperature, high, medium, and low levels. Press the button  once to switch to another level.

■ Seat Ring Temperature Adjustment

- Press the remote control button , and the main unit will respond with a "beep" sound prompt, entering the seat ring temperature setting mode. Adjust the seat ring temperature to your liking.
- The seat ring temperature can be adjusted to 4 different levels, including room temperature, high, medium, and low levels. Press the button  once to switch to another level.

■ Night Light

- This product is equipped with lighting function for convenient use at night.
- Pressing the button of  on remote control to turn on/off this light.

■ Nozzle Cleaning

- To activate this function while not seated, rotate the knob backward for three seconds.

■ Power Button

- The power button  on the remote control can be used to turn the smart toilet system on or off.

■ Flush by the Remote Control

- To flush the toilet once, press the flush button . If you want to flush continuously, there needs to be a 30-second interval between each flush.
- When the cleansing mode is activated, flushing the toilet will stop the cleansing function.

■ Flush by Foot Sensor

- Designed specifically for men's urination, no need to bend down to find the button or look for the remote control to flush, just place your foot in the sensing area to achieve flushing.
- To activate the flush, stretch your foot slightly against the sensor sign on the ceramic surface, and the water will start flowing once you remove your foot.

■ Flush by the Side Knob

- Press the knob down vertically to flush once.
- When the cleansing mode is activated, flushing the toilet will stop the cleansing function.

■ Power off

- **Hold the knob for 6 seconds when away from the toilet. To resume, hold for 3 seconds.**

Cleaning and Maintenance

■ Clean and Maintain the Power Plug

Please clean the power plug regularly. When cleaning, remove the power plug from the outlet and wipe it with a dry cloth.

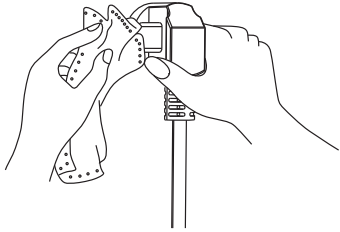

- Dust accumulation on the power plug may cause fire.

■ Clean and Maintain the Main Unit of the Smart Toilet

When cleaning the surface of the main unit, please wipe it with a soft, wet cloth.

- When cleaning and maintaining the smart toilet main unit, please pull the power plug out of the outlet to avoid any contact with water.
- If the surface has stubborn stains, you can use a soft, wet cloth with neutral kitchen detergent to clean it.



■ Clean and Maintain the Ceramic Part of the Smart Toilet

You can pour a neutral toilet cleaner onto a soft brush or sponge and use it to clean the ceramic part of the smart toilet. Rinse the area with tap water after cleaning.

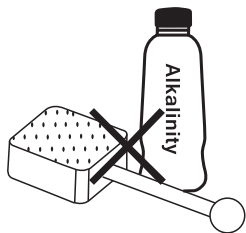
- Do not use detergents or disinfectants that contain chlorine or are acidic.
- Do not use brushes that contain abrasive materials.



■ Clean and Maintain the Nozzle

When the smart toilet is turned on, press the remote control button  or long press  to activate the nozzle cleaning function. The nozzle will extend and clean itself with water, and you can use a toothbrush to clean it at the same time. Please do not forcefully stretch the nozzle.

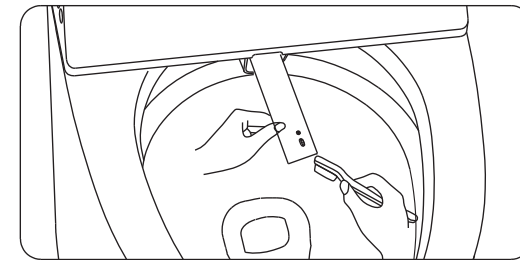

■ Clean and Maintain the Water Inlet Filter in the Valve

- Turn off the valve first to stop water supply.
- Remove the lock and the filter from the valve.
- Clean the filter with a brush or running water.
- Reinstall the filter. Make sure to screw it back in securely and not to leave behind the lock.
- Once the filter is cleaned and reinstalled, turn on the supply valve and check for any leaks. If there are any leaks, please double-check and reinstall the filter as needed.

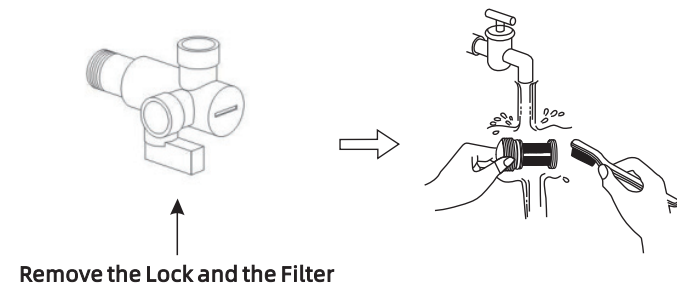

Remove the Lock and the Filter

■ When not in use for a long time

When not using this product for a long time, please be sure to drain all the water from the smart toilet to prevent water deterioration and freezing. Also, turn off the power and remove the battery from the remote control.

(1) Close the valve and stop the water supply.

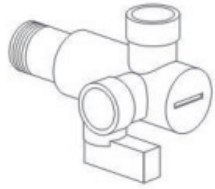

(2) Unplug the power plug from the outlet.

(3) Remove the water hose from the shut-off valve, drain the water from the hose, and then reinstall it.



● When using again, open the shut-off valve, plug the power plug back into the outlet, turn on the power to use.

■ When Freezing Occurs

In cold seasons, the smart toilet may be damaged due to internal freezing. To prevent freezing, keep the power connected and perform the following operations:

(1) Set the seat temperature and water temperature to the highest setting.

(2) If the water hose inside freezes and causes the spray water to be blocked and unable to be ejected, please use a cloth soaked in warm water to warm up the water hose and slowly thaw it. You can also turn on the heater to warm up the room and let it thaw on its own.

■ When Condensation Appears

Due to the difference in temperature and humidity between bathroom and the ceramic parts/surface of the smart toilet, water droplets (condensation) may appear on the ceramic parts and surface of the main unit. Please ventilate the bathroom sufficiently to avoid condensation.

● When condensation appears, wipe it with a dry cloth.

■ Replacing the Remote Control Battery

When the remote control becomes unresponsive or the indicator light does not light up, please replace the battery with a new one.

- When installing the battery, do not reverse the positive and negative poles.
- Do not use batteries of different ages or different types at the same time.
- When not in use for a long time, be sure to remove the battery.

Troubleshooting

Some malfunctions can be resolved by simple operations. Please confirm the following items before authorizing a professional to repair the product.

Problem	Possible Reason	Solution	
Press the power button and it does not work (the ambient light is not on).	Is the power outlet powered on?	Please confirm whether there is a power failure or whether the circuit breaker has tripped.	
	Is the power plug switch in the off position? (Is the power plug indicator light off?)	Press the reset button on the power plug to light up the indicator light.	
	Is the power plug plugged in properly?	Reconnect the power plug and insert it completely.	
The remote control is insensitive or unresponsive.	Is the remote control battery dead?	Replace with a new battery.	
The seat temperature, water temperature, and drying temperature are not hot enough.	Are the temperature settings appropriate?	Use the remote control to set the corresponding temperature.	
The button does not respond.	During normal operation, some buttons may not respond.	Some operations cannot be performed simultaneously (such as flushing during cleansing). Please read this manual carefully.	
The nozzle does not spray water or the water pressure is weak.	Alarm sound occurs.	Is the tap water turned off?	Wait for the tap water supply to be restored.
		Is the water supply valve open?	Turn on the water supply valve.
		Is the filter clogged?	Clean the filter.
	No alarm sound.	Is the water pressure too low? Is the water pressure setting on the remote control at the lowest level?	Press the button  to increase the water force.
		After sitting down, did you hear the prompt tone "beep"? Are you sitting within the effective range of the sensor?	Please sit on the seat and adjust to an appropriate sitting position.

Function List

CONFIGURATION FUNCTION	Item with Middle-level configuration	Item with High-level configuration
Aperient	●	●
Rear Cleansing	●	●
Rear Cleansing with Nozzle Oscillation	●	●
Front Cleansing	●	●
Front Cleansing with Nozzle Oscillation	●	●
Cleansing Strength Adjustment	●	●
Cleansing Position Adjustment	●	●
Cleansing Water Temperature Adjustmngt	●	●
Warm Air Drayer	●	●
Seat Sensor	●	●
Seat Ring Temperature Adjustment	●	●
Remote Control	●	●
Off Seat Auto Flush	●	●
Foot Sensor Flush	●	●
Flush by Remote Control	●	●
Flush by Side Knob	●	●
Night Light	●	●
Nozzle Cleaning	●	●
Nozzle Auto Cleaning	●	●
Power Outage Flush	●	●
Auto Lid		●
Foot Sensor to Open the Lid		●

● Indicates this product contains the function, blank indicates no function.

Remarks : The function of different items may be different from the above list , detailed function is in accordance with the actual product.

Product Specification

Rated Voltage	110V~ 60Hz	
Rated Power	1200W (water intake temperature of 59°F [15°C(±1°C)], water pressure of 0.24MPa, maximum level for front cleansing)	
Power Cord Length	About 39.37inch	
Water Pressure Range	0.15MPa (dynamic pressure) ~ 0.75MPa (static pressure)	
Overall Unit Waterproof	IPX4	
Product Dimensions	LWH: 26.77*15.75*18.11inch	
Product Weight	86.64LB	
Bidet Function	Water Heating Method	Instantaneous Heating
	Water Pressure	4-level adjustable
	Water Temperature	4-level adjustable: room temperature/34°C/37°C/40°C
	Maximum Power for Water Heating	1200W
	Safety Device	Thermal Fuse
Heated Seat Ring	Heating Power	40W
	Seat Ring Temperature	4-level adjustable: room temperature/34°C/37°C/40°C
	Safety Device	Thermal Fuse
Drying Function	Wind Speed	Greater than 8.9 mph (Greater than 4m/s)
	Heating Power	270W
	Wind Temperature	4-level adjustable: room temperature/40°C/45°C/50°C
	Safety Device	Reversible Thermal Protector, Thermal Fuse
Compliance Standards	Compliance with CSA B45.16:21 Personal Hygiene Devices for Water Closets & CSA B45.1-18 Ceramic Plumbing Fixtures standard.	

Acceptance Record

After the installation is complete, please test run the toilet and fill out the record sheet with the results:

Acceptance Item	Acceptance Result
Is the power outlet AC 110V±10%, load ≥1200W?	
Is the power outlet loose, or is the power connection in bad contact?	
Is each accessory securely connected without water leakage?	
Is the toilet's ambient light on?	
Is the bidet nozzle leaking?	
Is the "flip" function of the lid/seat working properly?	
Is the "rear cleansing" function working properly (including levels adjustment)?	
Is the "front cleansing" function working properly (including levels adjustment)?	
Is the "oscillating cleansing" function working properly (including levels adjustment)?	
Is the "water temperature" working properly (including temperature adjustment)?	
Is the "seat ring temperature" working properly (including temperature adjustment)?	
Is the "nozzle cleaning" function working properly?	
Is the remote control working properly?	
Is the manual and automatic flushing function working properly?	
Is the "drying" function working properly (including levels adjustment)?	
Remark:	
Retailer:	Installation personnel: Acceptance tester: Date: