

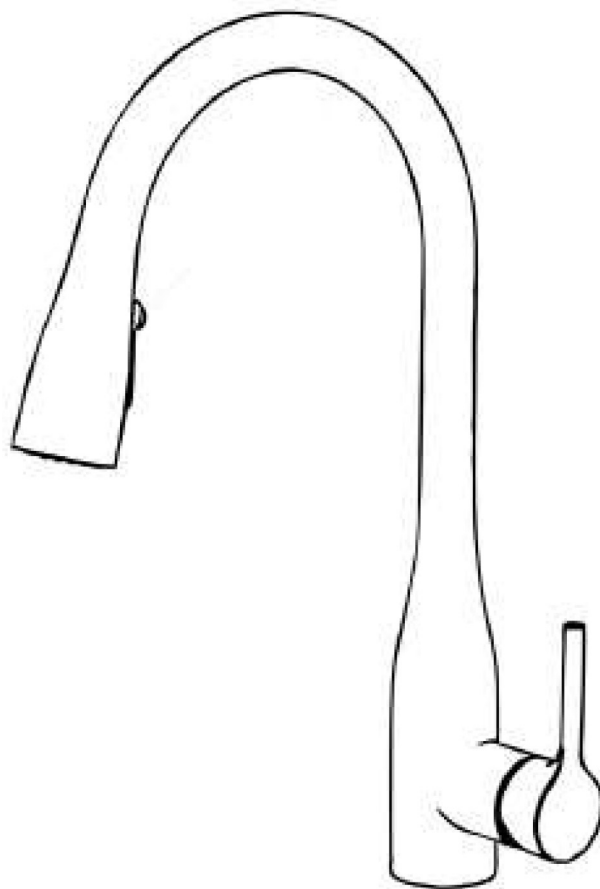

THE ANSWER TO IDEAL LIVING

# PRODUCT INSTALLATION MANUAL

WHEN IT COMES TO HOME, THIS IS THE BEST ANSWER.



**Parts list**

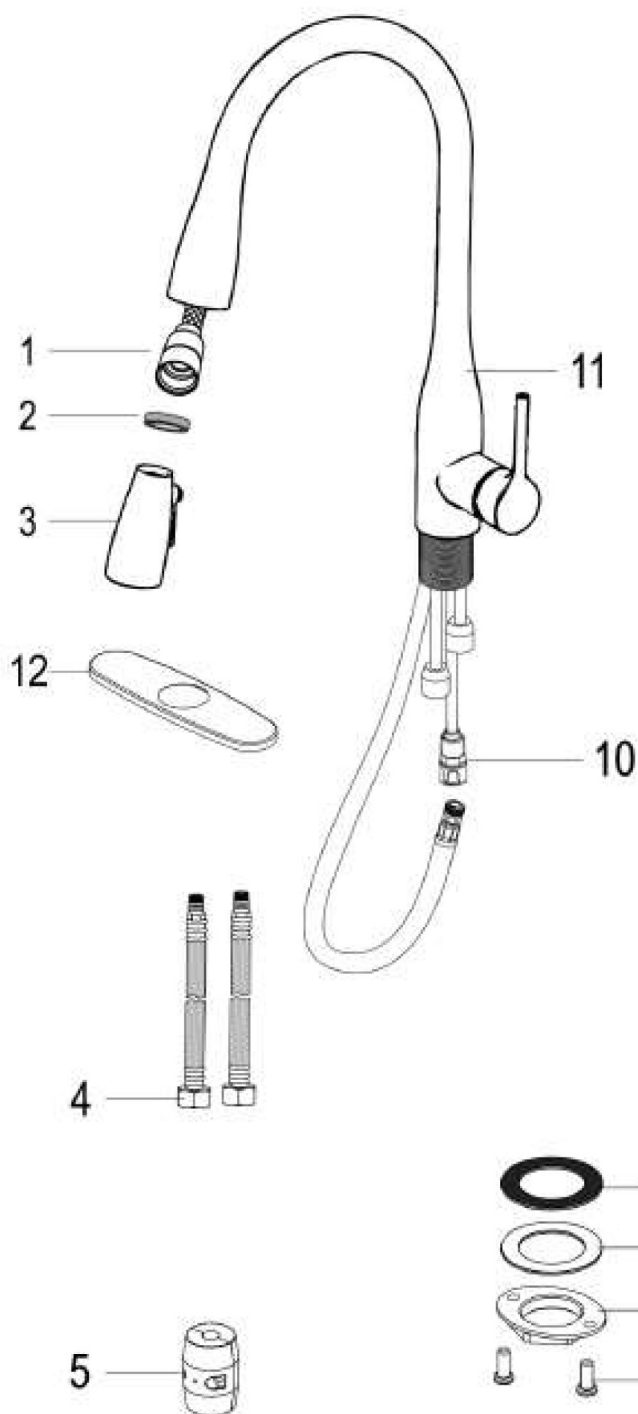

NO.	PART NAME
1	Shower hose
2	Washer
3	Sprayer
4	Hot & cold hose
5	Weight
6	Screw
7	Lock nut
8	Gasket
9	Washer
10	Quick connector
11	Body
12	Deck plate

Faucet installation

## Warranty Notes

1. Professional installation master is recommended during installation. If the product is damaged during installation without authorization, it will not be covered by this warranty
2. Damage caused by installation errors, product abuse, product misuse, or use of cleaners containing abrasives, alcohol, or other organic solvents is not covered by this warranty
3. MONDAWE products have been manufactured under the standards of quality and workmanship. MONDAWE faucets will be leak- and drip-free during normal use and a parts of this faucet will be free from defects in material and manufacturing workmanship. All purchasers (including purchasers for industrial, commercial and business use) are warranted for a period of 5 years from the original date of purchase.
4. If this faucet should ever develop a leak or drip during the Warranty Period, MONDAWE will FREE OF CHARGE provide the parts necessary to put the faucet back in good working condition use. Proof of purchase (original sales receipt) from the original purchasers must accompany all warranty claims. Defects or damage caused by the use of other genuine MONDAWE parts is not covered by this warranty.

Checking and testing

## Cleaning & Maintenance

To keep the product clean & shining, the following methods can be used:

1. Flush with clean water & dry with soft cloth only;
2. If any dirt, clean with soft liquid or transparent glass detergent;
3. Do not use any scrubbing detergent, polisher, sane-cloth, paper tissue or scraper;
4. Do not use acid detergent, indissolvable grain-like detergent or soap
5. Disassemble the aerator with a coin and clean it when necessary.



## Faucet installation

1

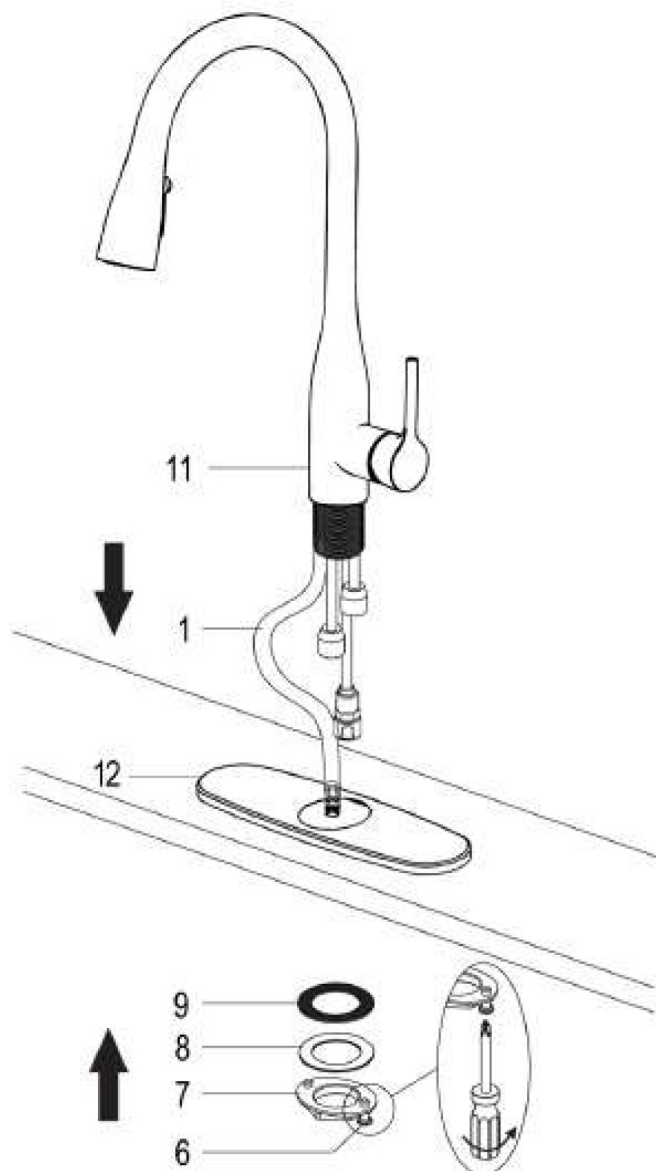

1. Position the deck plate and faucet on the counter top as shown. Assemble the washer, gasket and lock nut to the thread shank by hand and tighten the screws with screwdriver.  
(suggestion: Diameter for counter hole is 35-38mm.  
Counter thickness is 25-40mm)

Faucet installation

2

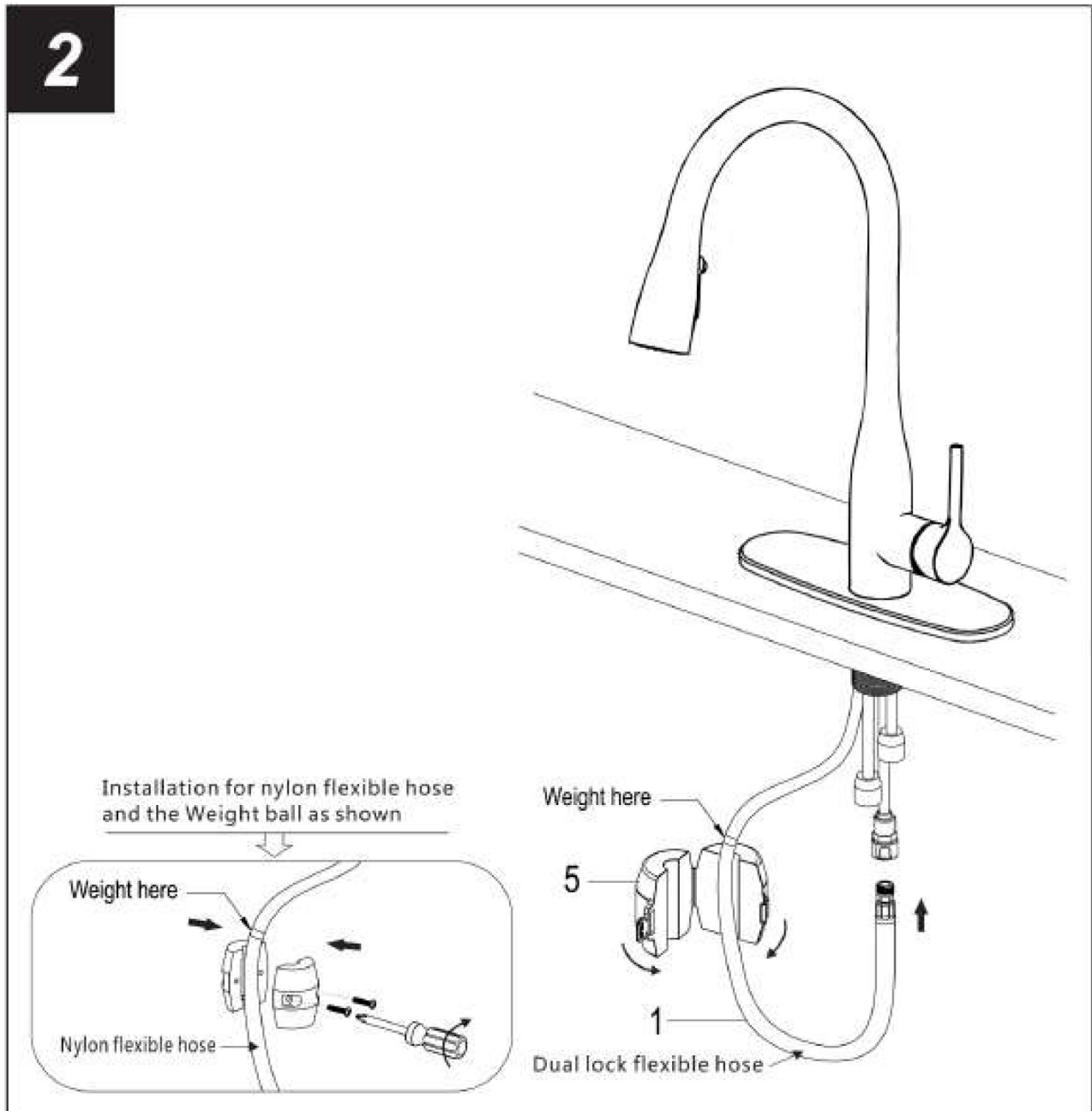

2. Connect the shower hose to quick connect.

**CAUTION: MAKE SURE THE HOSE IS PROPERLY ENGAGED AND SECURED IN THE QUICK CONNECT.**

Dis-assemble the weight and put it on the shower hose.  
Then fix screws by screw driver.

## Faucet installation

3

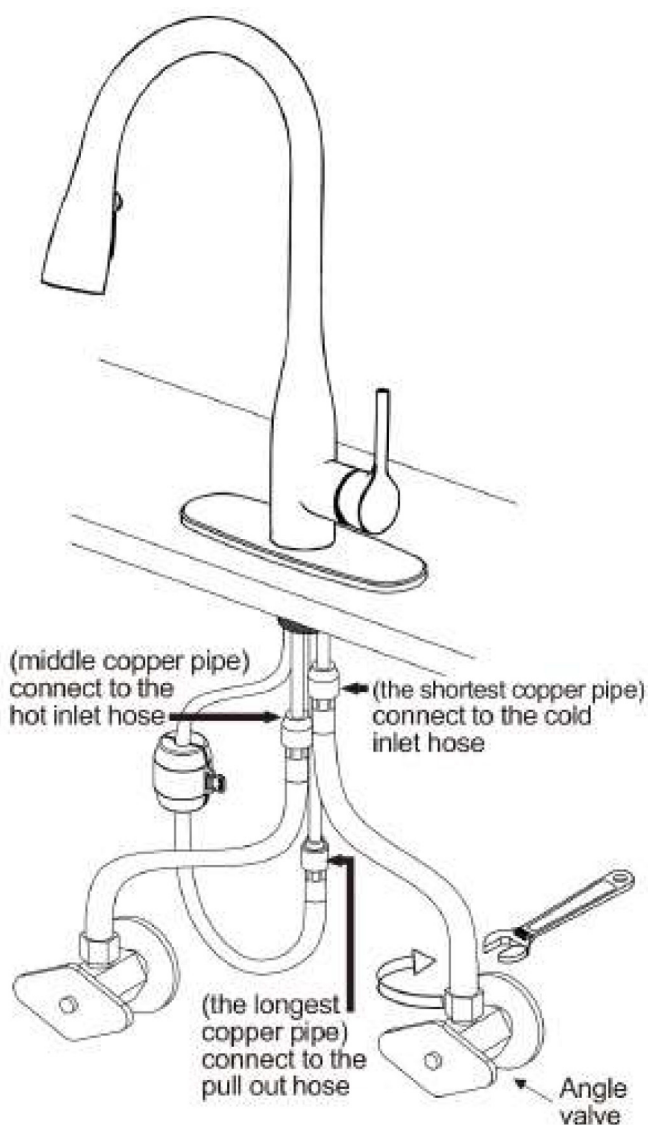
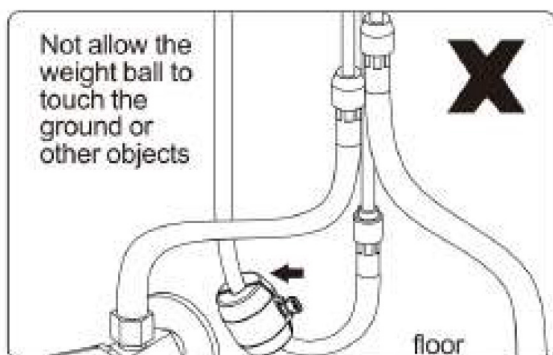
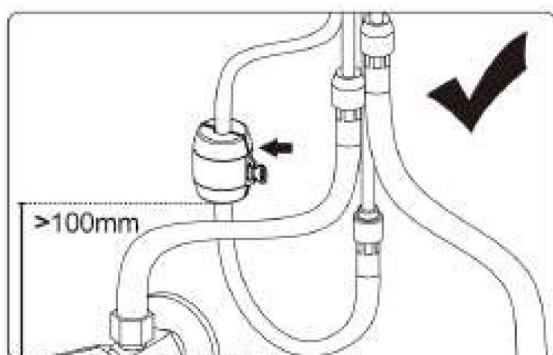

3. As the photo shows, assemble the hot/cold inlet pipe to the angle valve, and tighten it with adjustable wrench.

**DON'T OVER TIGHTEN!**

Caution: make sure connect the hot/cold hose correctly.

**!** Note: The components are not include angle valve.

## Recommend tools

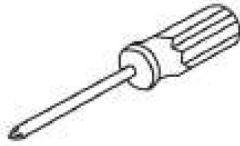

Screwdriver



Channel Locks



Goggles



Adjustable Wrench



Teflon tape



Allen key



**Attention:**

for easy installation, you will need:

1. To read all the installation instruction completely before beginning.
2. To read all the warning, attention and maintenance information.
3. To purchase the proper supply lines.

The tools might be applied to the following places:

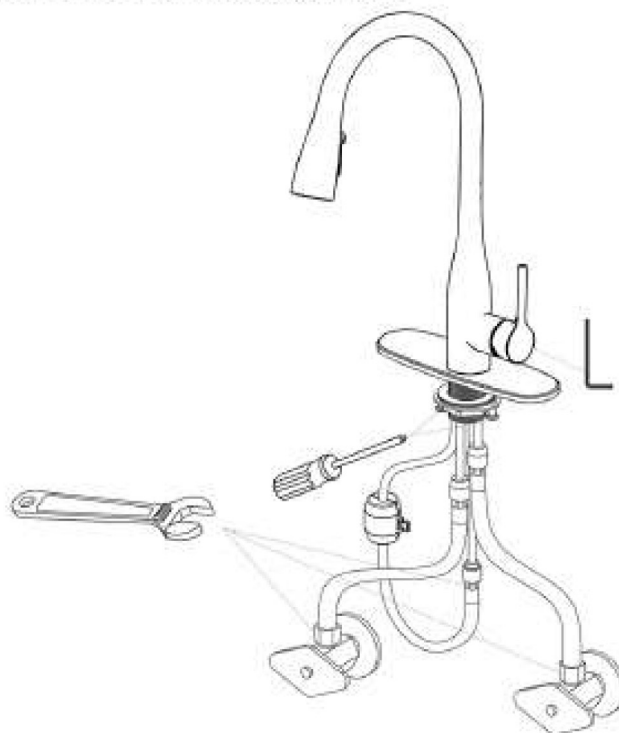



**Call us (9-8 EST): +1 888-257-3857**  
**Email us (24/5) : [service@casainc.com](mailto:service@casainc.com)**

**Message us : +1 562-551-8092**  
**For sales : [dtc@casainc.com](mailto:dtc@casainc.com)**