

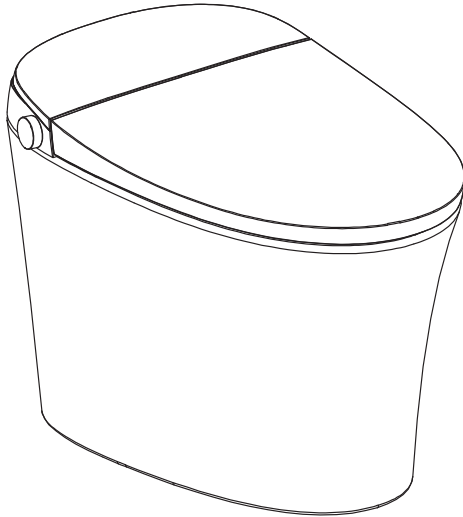

THE ANSWER TO IDEAL LIVING

# PRODUCT INSTALLATION MANUAL

WHEN IT COMES TO HOME, THIS IS THE BEST ANSWER.





# Contents

---

## Before use

---

Safety precautions .....	1
Overall sketch .....	6
Function introduction .....	7

## Installation guide

---

Toilet installation .....	8
Remote control bracket installation .....	11

## Operation

---

Operation introduction .....	12
Preparation .....	12
Product use .....	13
Troubleshooting .....	19
Cleaning and Maintenance .....	20

## Appendix



---

Product specification .....	22
Packing list .....	23



# Safety precautions



Please read the “safety precautions” carefully before use, all the precautions listed here are connected to safety. It's important and must be followed.

## Sign and meaning

	<b>Warning</b>	Represents improper operations by ignoring the instructions may result in death or injury
	<b>Notice</b>	Represents improper operations by ignoring the instructions may result in body injury and property loss

The following signs are used for important safety precautions.

Sign	meaning
	It represents not allowed, “forbid”
	It represents enforced to do

 <b>WARNING</b>	
	<p>Please do not touch the electrical outlet with wet hand</p> <ul style="list-style-type: none"> <li>• Or it may cause electric shock</li> </ul> <p>Please do not pour water, hot water or detergent on the top of the toilet and electrical outlet</p> <ul style="list-style-type: none"> <li>• Or it may cause fire, electric shock, heat or short circuit</li> <li>• Or it may cause injury and indoor water seepage because of the damage of product</li> </ul> <p>Never attempt to disassemble, repair, or alter the product yourself.</p> <ul style="list-style-type: none"> <li>• Or it may cause fire, electric shock, heat or short circuit</li> </ul> <p>Please do not install the toilet in car, ship or any other moving object.</p> <ul style="list-style-type: none"> <li>• Or it may cause fire, electric shock, short circuit or fault.</li> <li>• Or the ceramic, seat and main part will be damaged because of falling down.</li> </ul> <p>Stop using while it breakdown</p> <p>Under the following condition, please disconnect the power supply and turn off the water angle valve</p> <ul style="list-style-type: none"> <li>— Water leakage from pipe or inside of the product</li> <li>— crack or damage on the product</li> <li>— unusual sound or smell</li> <li>— Smoke</li> <li>— Unusual heating</li> <li>— Block</li> <li>— Fall out of the cushion</li> </ul> <ul style="list-style-type: none"> <li>• Continue using the toilet by ignoring the faults may result in fire, electric shock, heat, short circuit, injury and indoor water seepage</li> </ul>

 **WARNING**



Please don't use seawater and other water except tap water or drinkable well water (underground water)

- Or it may cause skin inflammation or fault

Please do not touch the electrical plug while thunder

- Or it may cause electric shock

Please do not let the water inlet soft pipe connect to the electrical plug and outlet

- Or it may cause fire, electric shock, heat, short circuit because of moisture condensation

Please do not destroy power cable or plug

Does not strike, yank, twist, excessively bend, damage, or alter the electrical cords. Also, do not place anything heavy on, bind or pinch the cords.

- Or it may cause fire, electric shock, heat and short circuit if it's broken

Please do not use a loose or faulty electrical outlet.

- Or it may cause fire or short circuit.

Please use the electrical outlet and wire appliance in specified area.

- Or it may cause fire because of wire appliance is not in the rule of outlet.

Please do not put finger or anything else into the warm air outlet.

Please do not put objects or clothes on the air outlet or cover it.

- Or it may cause scald, electric shock or accessories burn down.

Please keep cigarettes and other open flames away from the product

- Or it may cause fire.



Pay attention to the low temp scalding

- Improper use of warm seat may cause low temp scalding.

If you sit for long time, please turn the temp setting to "off" level.

Please turn the seat temp setting to "off" level, warm air dry temp to "low" level under following situations.

- Children and elders those who can not adjust the temp to the proper level
- Patient and disabled people those who have problem in behavior.
- People who have take medicine with hypnosis effect (hypnotics, cold cure and etc), or are excessive drinking, too tired and somnolence.

This is an electrical product, please do not install it in a place where is easily get wet or with high humidity. If installed in bathroom, please also install ventilator to maintain the bathroom ventilation.

- Or it may cause fire or electric shock.

The product must be connected to cold water supply.

- Or it may cause body burn or machine fault.

The product must be connected to the ground correctly.

- If not connected to the ground, it may cause electric shock.

The ground processing here requires the ground resistance under 100Ω, the earth wire of switchboard is over Ø1.5mm, with copper material. (please entrust installation company to do the job)

 **WARNING**

Please confirm if the electrical outlet is connected to the ground

- Or it may cause electric shock because of fault or short circuit.

The outlet for power wire should obey the following rules.

- Or it may cause fire or electric shock.
  - a. Please use high sensibility and fast respond leakage switch (rated induced currents below 15mA) or insulating transformer (1.5kVA~3kVA) to protect outlet loop.
  - b. Please reserved the installation place for outlet and keep it away form bathtub.
  - \* Please confirm above a , b wiring projects are finished. Or please entrust the engineering contractor to do this job.

The electrical plug should be inserted to the outlet firmly.

- Or it may cause fire, heat or short circuit.

Please hold the plug not the wire when pulling out the plug.

Please do not grasp the wire to pull out the plug.

- Or it may cause fire or heat because of broken wire.



If the power soft wire is broken, to avoid danger, please ask the maintenance department of company or similar departments to replace it.

Please be sure to turn off the power while doing the maintenance or spot check.

- Or it may cause electric shock or accessories burn down.
  - \* Not include “ nozzle clean”

Disabled people or who is lack of experience or common sense ( including children) should be accompanied with personnel guardian while using this product.

- Or it may cause scald, electric shock, fire and body injury.

Please do not let children play this product.

- Or it may cause scald, electric shock, fire and body injury.

Do not throw lighted cigarettes and other flaming material into the toilet.

- Or it may cause fire.

Strong magnets inside, the body is equipped with a pacemaker and other auxiliary medical equipment, please do not use.

 **NOTICE**



Please do not use the product when it's loose.

- Or the toilet and seat may separate and fall off to cause body injury

Please do not touch broken area.

- Or it may cause injury, please replace it as soon as possible.

Please do not impact forcefully, put heavy subject or stand on the product

- Or it may cause product damage, fall down or body injury
- Or it may cause body injury or indoor water seepage

Please do not pull the product by holding the seat or cover.

Please do not open the seat and cover when something on the product.

- Or the main body may fall off to cause body injury.

Please use kitchen detergent(neutral) to maintain the plastic part(seat cover, etc) and water inlet soft hose, please do not use the following materials

[ bathroom detergent, house detergent, gasoline, banana oil, cleaning powder and nylon brush and so on]

- Or it may damage the plastic parts, cause cracks to body injury for fault
- Or it may cause water leakage because of damaged soft hose

To avoid sudden water leakage, please do not remove the water inlet filter when angle valve is open

[please refer to cleaning instruction of water inlet filter]

- Or the water may spray out

Please do not crush or bend water inlet hose

- Or it may cause water leakage

Please use the new hose that put inside the accessory box, the old one isn't recycled.

- Or it may cause water leakage

Please do not pour hot water into toilet

- Or it may cause body injury or indoor water seepage because of toilet damage

Please do not flush with big amount of toilet paper or other subjects except sewage and small amount toilet paper.

- Or it may cause body injury or indoor water seepage because of toilet damage

Please do not lean on the toilet cover while using

- Or it may destroy the seat cover.



## NOTICE

Please close the angle valve when water leaking

When room temp is under 0°C(32°F),to avoid piping or soft hose damaging because of frozen, anti freezing measures should be adopted.

- It may destroy main body or piping, leading to water leakage if water inlet soft hose is frozen.
- To avoid damage, please pay attention to room temp adjustment.

When not use for a long time, please must drain the inlet soft hose, and cut the power.

- When using next time, please open the angle valve and let water connected first. or it may cause skin inflammation because of bad water quality.
- It may cause fire or heat if the power supply is always connected.



Please must confirm if the filter has screwed to right position when install it.

- It may cause water leakage if not screwed tight.

When the toilet drain outlet is blocked, cut off the power then clean the obstruction

- Or the sewage may overflow, cause indoor water seepage because of auto flush function.
- Use the professional tools sold in the market to clean the obstruction.

Flush the toilet after pee

- Or it may cause difficulty in clean the toilet, block the drain outlet or sewage overflow, result in indoor water seepage.

Use the dried towel to clean the pee, dee, detergent, water and etc on the floor.

- Or it may leave dirt on the floor or corrode the floor.

# Overall Sketch

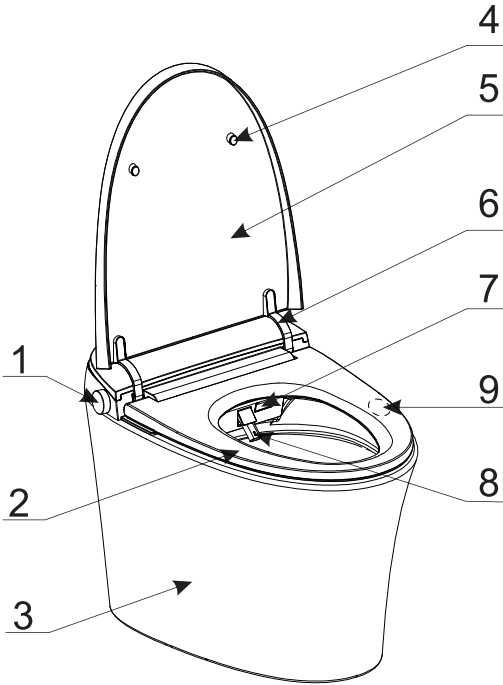

- 1 Side knob
- 2 Heated seat
- 3 Toilet bowl
- 4 Cushion pad
- 5 Toilet lid
- 6 Damper
- 7 Dryer outlet
- 8 Nozzle
- 9 Sensing area

## Remote control

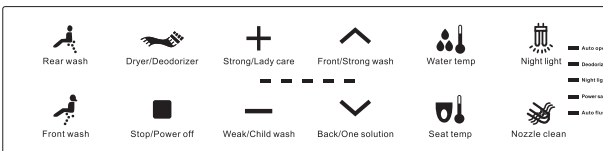

## NOTICE

The contents described in this manual include but are not limited to product material, process, functional characteristics, etc., which may be different from the actual product due to process improvement or product upgrade. Please refer to the actual product.

# Functions introductions

Function	Introduction
Rear wash	Provide rear cleansing
Rear oscillating Wash	Move the nozzle back and forth for rear cleansing
Front wash	Provide cleansing by front cleansing nozzle with a gentle spray
Front oscillating Wash	Move the nozzle back and forth with a gentle spray
One solution	Auto clean, flush and dry
Nozzle position adjustment	Adjust the suitable washing positions
Temperature adjustment	Set the temperature of seat and water
Water pressure adjustment	Change cleaning water pressure
Seat sensor	Functions activated by sitting on the seat
Drying	Dry the users after cleansing
Changing drying intensity	Control the temperature of warm air from the dryer
Nozzle self-clean	Provide nozzle self-cleaning before washing
Smart remote control	Use the remote control to set up and control the toilet
Deodorizer	Removing odors
Saving energy	Saves electricity
Night light	Preparations for insufficient light
Soft close	Damper in the seat and cover, to make it close softly
Auto flush	Auto bowl unit cleaning after users walk away
Power switch	Turn power on and off
Flush even if power off	Push side button to flush when power off
Ceramic bowl pre-wet	Water come out of the nozzle to make the ceramic bowl wet
UV sterilization	Automatically activate after the human body left the seat
Auto open-up seat	When the human body is close to the toilet, the seat cover opens automatically and close automatically when leaving

\*Remark: Function is different depending on the model configuration

# Installation method

## ◆ Toilet installation ◆

### ※ Supply stop installation

1. Turn on the old supply stop and flush for 1 minute, to flush out any sundries that may damage the toilet structure.
2. Turn off the supply stop and remove it.
3. Wrap sealing tape on the end (1/2" NPT male) thread of the water supply pipe (not provided) to ensure good sealing performance. Screw the adapter onto the water supply pipe.
4. Use Teflon tape to ensure good sealing performance. Make sure start wrapping at the end of the fitting, covering the end to prevent the thread from seizing. For the joint assembly, you should tighten the threaded joint 1-2 turns beyond finger tight, be careful do not over tighten.

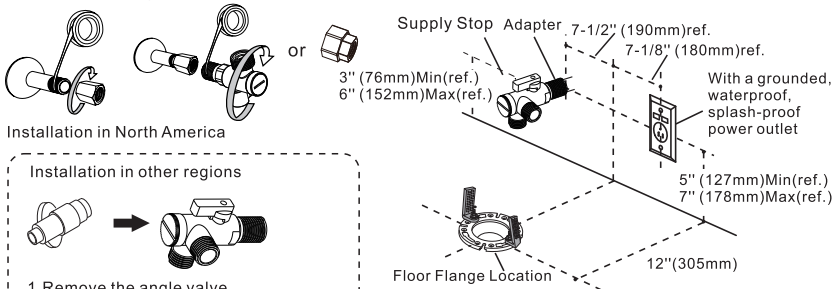

1. Remove the angle valve.
2. Replace the smart toilet angle valve.

### ※ Confirm water flow

1. Install a matching hose, which is guided to a bucket of 3 gallons (11.4L) or more. If you cannot find a matching hose, you can use a cloth to cover the outlet of the supply stop and place the bucket under the valve.
2. Turn on the supply stop. Ensure that the water can outflow at least 1.19 gallon within 15 seconds.
3. If the water pressure is too low, it is recommended to remove the flow regulator of the pulse valve or use a booster pump to increase the water pressure.
4. Close the supply stop.
5. Remove the installed hose.

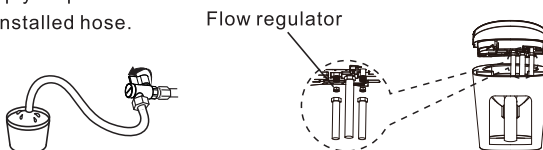

## ❖ Installation

**Note:** If the distance between the sewage outlet and the wall surface is less than 12" (305mm), the toilet lid may touch the wall surface when opened.

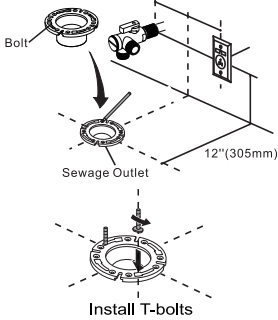

For new installations, a toilet flange needs to be installed.  
Install the fixed column.  
Mark the installation position of the flange and install the flange.

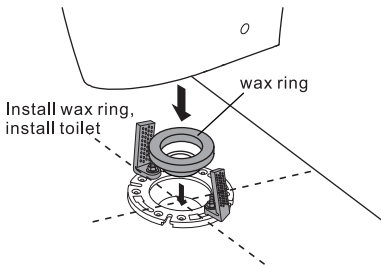
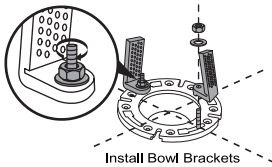

Install the fixing bracket.  
Align the toilet drain hole with the flange and install it to the floor drain hole.

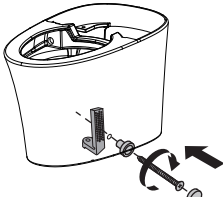

Align the self tapping screw with the ceramic side holes and bracket to fix, tighten the screws and install the screw cover.

Installation in North America

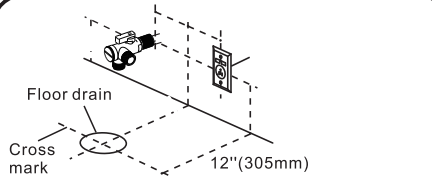

Make a cross mark on the floor drain, clean the floor and dry the water.

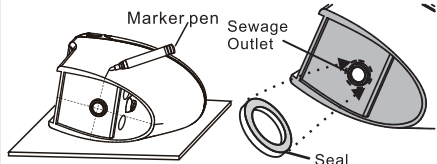

Gently flip the toilet, place it on the pre-prepared foam board.

Take the sewage outlet of ceramic body as the center point, make a mark on the side of the toilet bowl, it perpendicular to the bottomplane of the toilet bowl, the other side same as above. At the same time make a mark in the middle of the front of the toilet bowl, it perpendicular to the ground. Install a sealing ring under the toilet.

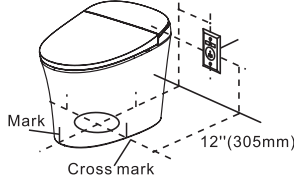

Lift the toilet, align the mark on the toilet bowl with the cross mark on the ground, and place the toilet slowly adjust to the ground so that the two marks coincide. Press the toilet down to make the seal ring gasket full contact with the ground and make a tight connection with the ground.

**Note:** Do not move toilet or shake it from side to side after the marks coincide, otherwise the seal caused by the seal ring gasket may be damaged, leading to water leakage.

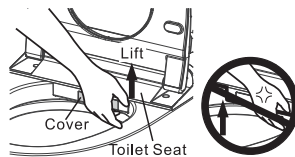

Lift the toilet seat-lid assembly from the toilet. Lift from the interior, back right.

**Note:** Do not excessively pull the cover when lifting the toilet seat-lid assembly.

Installation in other regions

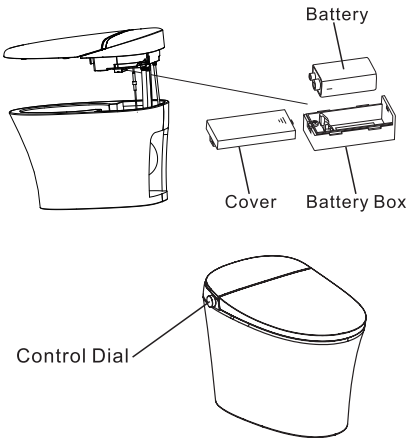

1. Carefully remove the cover of the battery case.
2. Connect and install the battery and slide the cover back to the battery box.
3. Press the control dial on the side to confirm that flushing can be normal.

**Note:**

- Use alkaline battery.
- This battery is used to maintain the flushing function in the event of power failure.
- Don't throw used batteries into the garbage can, please throw them into your local battery collection center.

**Test run**

Follow the instructions "use instruction" and check that all functions of the product are working properly.

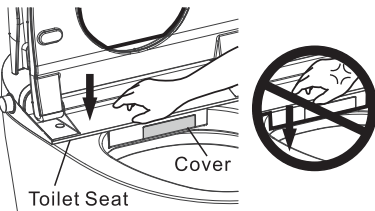

Reinstall the toilet seat-lid assembly to complete the toilet installation.  
Note: Do not push too hard when putting back the toilet seat-lid assembly.

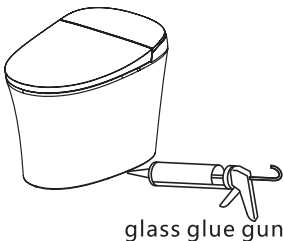

glass glue gun

Use a glass glue gun to apply the glue along the bottom of the ceramic.

- ※ Please allow 48 hours after applying the glass glue before using.
- ※ When adjusting the product, please make small and gentle adjustments, do not over-adjust.
- ※ Do not pour cement mortar into the front cavity or other cavities to avoid cracking the ceramic as the cement expands.

## ◆ Install the remote controller ◆

■ The following picture shows the installation method

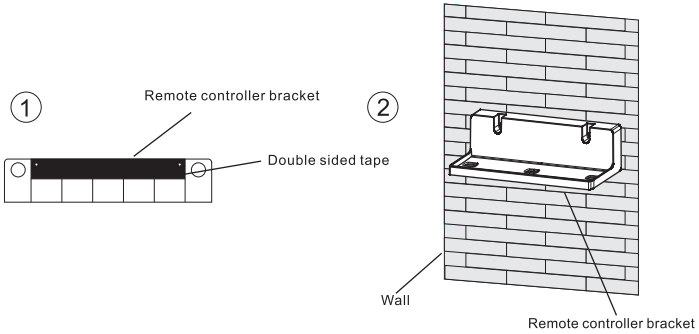

Tear the paper of double sided tape on the back of bracket,  
stick the bracket on the wall

Notice: Clean the installation position before pasting. Strongly  
and evenly press the tape when pasting. Use it after 15 minutes.

# Operation

## ◆ Operation introduction

- ※ The design of this product is mainly controlled by remote control, and the side knob control of the product is supplemented.
- ※ The following just shows function introduction.

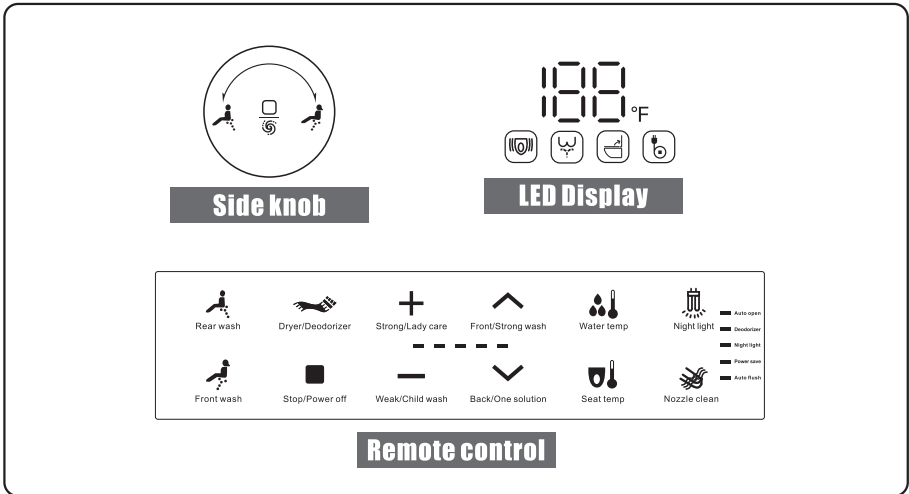

## ◆ Preparation

1. Confirmation of water connection.

2. Make sure that the power is on.

3. After the machine is powered on and initialized, the default is turned on, and the parameters such as water temperature, seat temperature, auto deodorization, and auto flushing are auto restored to the settings before power off.

4. If it is not powered on, press the power button on the side knob to power it on.

## ◆ How to use

### Sit on the seat

Seat Sensor react automatically when sitting on the seat.  
Water comes out to pre-wet the inner ceramic bowl.  
Deodorizing starts when deodorizer activates automatically.

### Water pressure adjustment

Press this key to provide 4 cleaning pressure selection during washing.

### Stop

Press this key will stop cleaning before the automatic stopping.  
Long press for 3s to turned off.

### Nozzle position adjustment

Press this key during rinsing to provide 5 cleaning position choices.

Note: When the swinging cleaning function is on, the nozzle position cannot be adjusted.

### Reminder

The number below the remote control indicator is referenced only for functional instructions and actual remote does not have this number.

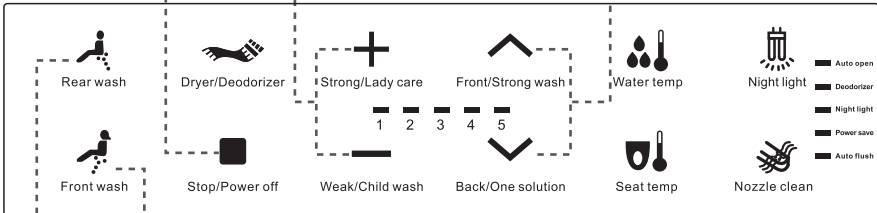

### Rear wash

This function only works when the user is sitting on the toilet seat. Press this key to extend the nozzle and rinse the buttocks. Press the key again to start swinging cleaning. The first light on the left of  flashes. Press the key for the third time to switch back to rear washing. The rinsing stopped after 2 minutes.

### Front wash

This function only works when the user is sitting on the toilet seat. Press this key to extend the nozzle and rinse the front position. Press the key again to start swinging cleaning. The first light on the left of  flashes. Press the key for the third time to switch back to bidet washing. The rinsing stopped after 2 minutes.

### Night light

Press this key to turn on or off the light. The "Night light" light on the remote control will turn on or off synchronously.

### Nozzle clean

This function only works when the user leaves the toilet seat. Press this key, the nozzle extends out, its surface is washed by water automatically. You can use a brush to clean the nozzle. Press the "Stop" key to retract the nozzle.

Note: Before starting bidet washing or rear washing, the nozzle extends out and its surface is washed by water automatically.

### Warm air temp adjustment

Press this key to provide 4 drying temperature selection during drying.  
Long press for 3s to turned off.

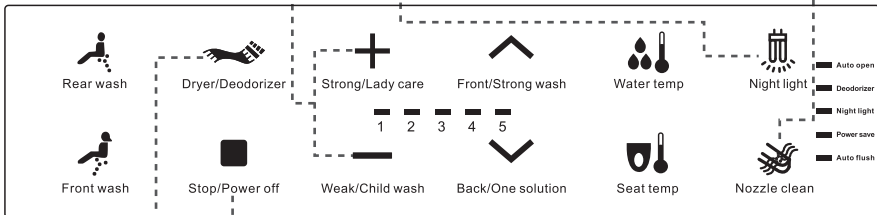

### Dryer / Deodorizer

This function only works when the user is sitting on the toilet seat. Press this key to start warm air drying. The drying stopped after 4 minutes. Press for 3 seconds to start deodorization. The deodorization light on the remote control lights up. Press again for 3 seconds to close.

Note: Deodorization stops working when the hot air drying is on, it starts again when hot drying is off. Deodorization will continue to work for 1.5 minutes after the user leaves the seat.

### Stop

Press this key will stop drying.

## Lady care

This function only works when the user is sitting on the toilet seat. In standby mode, press this key to extend the nozzle and wash. The water temperature is 102.2°F (39°C). The water pressure is set to level 2. The cleaning position can be adjusted, and the temperature and water pressure cannot be adjusted. Cleaning will stop within 2 minutes or stop by pressing the "Stop" key before the end of the countdown.

## Water temp

Pressing this key will set 4 water temperature for the cleaning. 4 settings: off (normal temperature)/low/medium/high. The more lights  on, the higher the temperature.

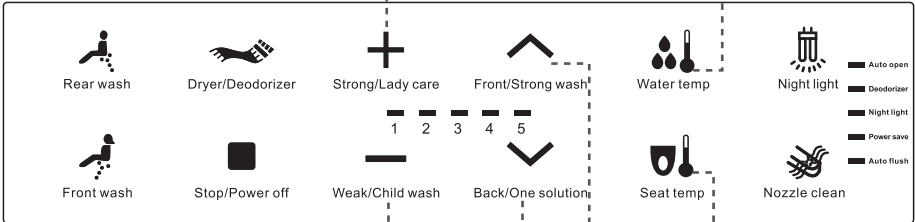

## Child wash

This function only works when the user is sitting on the toilet seat. In standby mode, press this key to extend the nozzle and wash. The water temperature is 96.8°F (36°C). The water pressure is set to level 1. Cleaning position, temperature and water pressure cannot be adjusted. Cleaning will stop within 30 seconds or stop by pressing the "Stop" key before the end of the countdown.

## Seat temp

Pressing this key will set the 4 temperature for the seat heating. 4 settings: off (normal temperature)/low/medium/high. The more lights  on, the higher the temperature. Attention: To prevent the low temp scalding, the toilet seat will automatically lowered to below 35°C after sit on the seat for 10 minutes.

## One solution

This function only works when the user is sitting on the toilet seat. In standby mode, press this key to start. Cleaning sequence: rear washing for 40 seconds—swing cleaning for 20 seconds—warm air drying for 2 minutes—stop. Or press the Stop key to terminate before the end of the countdown.

## Strong wash

This function only works when the user is sitting on the toilet seat. In standby mode, press this key to extend the nozzle and wash. The water pressure is set to the maximum value. The cleaning position and the temperature can be adjusted. Cleaning will stop within 2 minutes or stop by pressing the "Stop" key before the end of the countdown.

### Reminder

Idle mode means rear wash, front wash, dryer, flush, etc. are not working.

Child wash, one solution, strong wash, lady care must be enabled in idle mode.

### Open/Set

Pressing this button to open-up the seat when the seat is closed. Long press 3 sec to turn on the automatic seat function. The Auto open indicator of the remote control lights up. The seat is automatically opened when the person is close to the toilet. The seat is automatically closed after a person has left for 2 min.  
 Note: Automatic opening or closing of the seat is valid only after opening the automatic seat function; The sensor only detects the movement of the human body, and when standing still for a long time, it may cause abnormal movement. During the electric opening and closing process, do not forcibly close or sway, causing malfunction.

### Close/Power save

When the seat is open, pressing this button to soft close the seat; Long press 3 sec to start power saving mode. press another 3 sec to close it. After person left of 1.5 min, enter power saving mode. In the power saving state, the seat temperature is kept at 77°F(25°C), and the next time is to automatically restore the settings before the power saving.

### Flush/Auto flush

Press this key to flush the toilet once. Press for 3 seconds to start automatic flushing. The automatic flushing light on the remote control on. Rinse automatically 5 seconds after leaving the seat. Press the key again for 3 seconds to turn off the automatic flushing function.  
 Note: In the automatic flushing mode, when the user sits on the seat and flushes the toilet by pressing the control dial or this key of the remote control, the toilet will not flush again after the user leaves the seat.

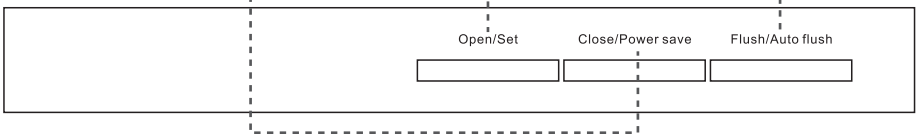

### Reminder

After the power on initialized of the machine is complete, the default power on, water temp, seat temp, automatic deodorization, automatic flushing and other parameters automatically return to the settings before power off.

### Reminder

Working mode distinction:

1. Operation mode: It is in the working state of rear wash, front wash, drying, flushing, nozzle cleaning, etc.
2. Idle mode: refers to the idle waiting state in non-operating mode;
3. Standby mode: When press the power on the side of the remote controller or side button, the machine enters the standby state, and the power consumption is the lowest.

## Product side knob

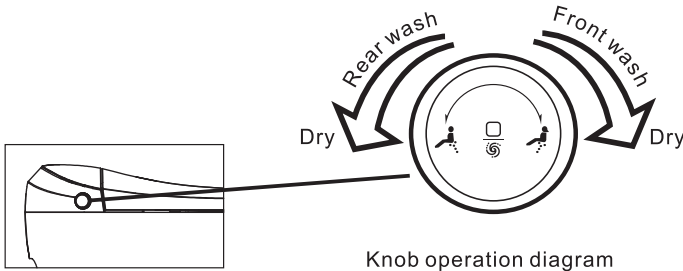

- 1) . In the off state, Knob indicator is not lit, rotate forward/backward/press and other actions will start. Product automatically enters idle mode, indicator shown as light pink, effect; same as breathing light.
- 2) . In idle and off seat mode, functions won't work if rotate forward or backward, indicator shown as light pink;
- 3) . When people sit on the seat, product start working, Knob rotates forward , then turn on automatic front wash function. First wash for 1minute, then warm air dry for 2 minutes; If you rotate forward again during the automatic front wash, stop front wash and turn on the warm air drying function. The indicator light is pink for front wash, red for warm air dry;
- 4) . When people sit on the seat, product start working, knob rotates backwards, then turn on automatic rear wash. First wash for 1 minute, then warm air dry for 2 minutes;If you rotate backward again during the automatic rear wash, stop wash and turn on the warm air drying function. The indicator light is blue for rear wash, red for warm air dry;
- 5) . When people sit on the seat, the product is in the rear wash/ front wash / dry working state, press the knob then the three functions stop, enter idle mode, the indicator is light pink;
- 6) . When the product is on idle or power off mode, press the knob to start flushing. Flushing while in idle mode, indicator light is light red;
- 7) . Continuously press knob two times to start water saving mode (small flush) ;
- 8) . In the power on state, long press the knob for 3s to turn it off, indicator light is off.

## Buzzer

Buzz once: Sit on seat condition, all the functions are available.

Buzz twice: Off the seat condition, parts of the functions are available.

Buzz three times or more: There are faults of the product.

Reminder

Buzzer only works when operate on remote controller or side button or initialization.

## Foot sensor control

When the seat ring and the seat cover are closed, the seat cover opens when the foot get close the sensor, again, the seat ring opens. When seat ring and the seat cover are opened, at first, the seat ring and the seat cover are closed when the foot get close the sensor, and then the flushing start.

Notice: When the human body is seated, the sensor will have no effect. The foot flush is performed as a small flush.

※ Foot sensor flush and foot sensor for open up cover functions are optional functions.



## UV sterilization

When the human body leaves the seat for 15 seconds, the UV sterilization function will automatically works and sterilizes the nozzle for 3 minutes. Every 4 hours, it will start again.

Note: This function will be different due to different model configurations.

During the operation, do not look it directly, otherwise it may cause permanent damage to the eyes.

## Remote control code matching

If one user has more than two items of the same brand smart toilet, there maybe interaction while using remote control. In this condition, using the remote control code matching function to ensure the uniqueness between the remote control and the toilet. When performing this operation, you must unplug the power of other nearby smart toilets.

1. Plug off the smart toilet power.
2. Press "weak" and "back" button at the same time, leave it until the indicator light constantly blinking
3. Plug on the smart toilet in 5 seconds.
4. Match code completed when the remote control indicator light stop blinking.

**Notice:** Remote control match code time is 10s, auto quit if overtime operation

## LED Digital Display

When different functions are activated, the corresponding function animation is displayed or the indicator light is on.

The  icon indicates the seat temperature. When adjusting the temperature, the icon lights up, and the current temperature is displayed.

The  icon indicates the cleaning water temperature. When adjusting the temperature, the icon lights up, and the current temperature is displayed.

The  icon indicates that the microwave induction function is activated.

The  icon indicates that the energy-saving mode is activated.



## ◆ Trouble shooting ◆

SITUATION	REASON	PROCESS
No power	The electrical outlet is not connect to power supply or the plug is not insert to the bottom	Check if the electrical outlet is connected to the power supply; press the reset key on the plug
No water comes out while cleaning	Low pressure of water supply	Raise the water pressure
	Water inlet filter blocked	Remount and clean the filter according to the instruction
Cleansing water in not warm enough	Water temp setting is incorrect	Readjust
Seat does not heat	Seat temp setting is incorrect or the product is in power saving mode	Readjust
Seat and cover are loose	Fixed bolts are loose	Tighten the bolts
Remote controller failure	Battery runs out	Replace battery
No response when pressing the key	Key fault	Reboot or contact ascendant
Water leakage	Shutoff valve, water supply hose and water separator are not well connected	Reconnect

# Cleaning and Maintenance

## • Toilet bowl cleaning

- ◆ Please make sure the electrical plug is taken out
- ◆ Please use wettish soft cloth to wipe the toilet shelf and seat.  
The dirt should be cleaned as soon as possible, if it's difficult to clean, you can use neutral detergent.

## • Nozzle Cleaning and Maintenance

- ◆ Press "nozzle clean", nozzle will come out and start auto wash, then you can use brush to clean it.

Attention:  
Do not use steel brush to clean

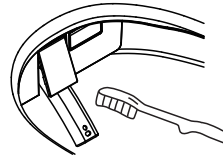

## • Cleaning the filter

When the water pressure is too low or insufficient, please clean the filter.

1

### Close the angle vane and stop water supply

Notice: Do not remove the filter without closing the angle valve.  
---Otherwise water will spray out.

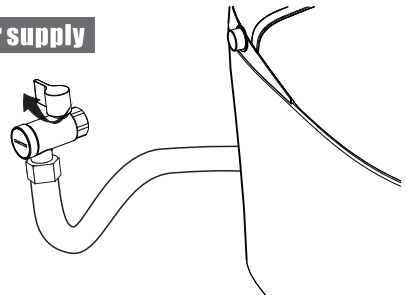

## 2 Remove the filter

Unscrew the cover of the filter by straight screwdriver and then pull out the cover as below:

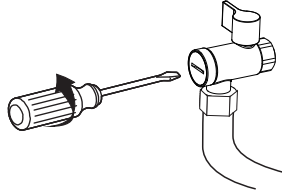

## 3 Clean the filter

Get the filter out and clean it thoroughly.  
-----Flush off dirt or clean the filter by toothbrush

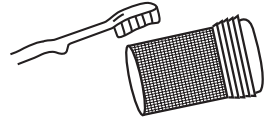

Note: Do not use any cleaning agents. Clean it with water only.  
Do not crush the filter when cleaning in case of distortion.

## 4 Reattach the filter

Reinstall filter based on the removal sequence.

Notice: Open the shutoff valve after installation and confirm there's no water leakage.

## • Replace the remote control battery

- ◆ When the battery is running out, the remote controller is sometimes insensitive and sometimes out of control and you should replace the battery at this point

### ※ Attention

The positive and negative poles of the battery must be placed correctly, and the compression spring protrudes from the negative pole.

New and old batteries cannot be mixed

Please use alkaline battery

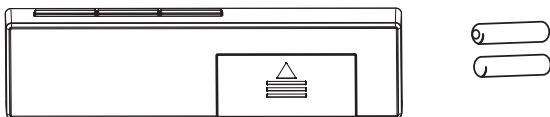

# Appendix

## ◆ Product specification ◆

Ambient temp range		4°C-40°C(39.2°F-104°F)		
Inlet water temp range		5°C-35°C(41°F-95°F)		
Rated voltage		<input type="checkbox"/> 220V~ 50Hz	<input type="checkbox"/> 110V~ 60Hz	Inlet water temp: 15°C±0.5°C (59°F±32.9)
Rated power		1200W	1200W	
Power cord length		1.5m (0.95m for North America)		
Cleansing device	Water pressure range	0.14MPa-0.75MPa(Flow volume is no less than 18L/min)		
	Water pressure adjustment	Adjustable in 4 paragraph		
	Water temp adjustment	4 paragraph adjust:Room temp,33°C(91.4°F), 36°C(96.8°F),39°C(102.2°F)		
	Safety device	Temp sensor control system、Dry burning-resistant protection device、over temp protection system、water and electricity isolation system		
	Rear wash	0.4-0.6 L/min(water pressure≥0.15MPa)		
	Front wash	0.4-0.65 L/min(water pressure≥0.15MPa)		
Seat heating device	Seat temp control	4 paragraph adjust:Room temp,33°C(91.4°F), 36°C(96.8°F),39°C(102.2°F)		
	Seat protective system	Temperature sensing control system/ fuse		
Warm air dryer	Warm air temperature	4 paragraph adjustable:35°C(95°F),42°C(107.6°F),48°C (118.4°F),54°C(129.2°F)(The wind temp is greatly affected by the environment,and the values are for reference only.)		
	Safety device	Temperature reset switch/fuse		
Deodorizer		Catalyst deodorant box		
Remote control		YES		

Cleaning rate test: In the seated state, the knob is turned to the rear wash for more than 3 seconds to start the wide-width cleaning mode.

## ◆ Packing list ◆

Dear user

Please check whether the products are complete after you open the box of toilet. Product packaging box containing the items are:

1 Smart toilet

1 Manual

1 Drainage pipe

1 Angle valve

1 Set remote control (Including remote control, bracket, double side tape,  
2 AAA alkaline batteries)

1 Set of floor row mounting fixing bracket ( Flange , 2bowl brackets ,  
2t-bolt , 2plastic spacers , 2screw cover , 2self tapping screw )

## Warning

1. This appliance is not intended for use by persons (including children) with reduced physical, sensory or mental capabilities, or lack of experience and knowledge, unless they have been given supervision or instruction concerning use of the appliance by a person responsible for their safety.
2. Children should be supervised to ensure that they do not play with the appliance.
3. If the supply cord is damaged, it must be replaced by the manufacturer, its service agent or similarly qualified persons in order to avoid a hazard.



**Call us (9-8 EST): +1 888-257-3857**  
**Email us (24/5) : [service@casainc.com](mailto:service@casainc.com)**

**Message us : +1 562-551-8092**  
**For sales : [dte@casainc.com](mailto:dte@casainc.com)**