



THE ANSWER TO IDEAL LIVING

PRODUCT INSTALLATION MANUAL

WHEN IT COMES TO HOME, THIS IS THE BEST ANSWER.

CARTRIDGE

- Pressure Balance cartridge

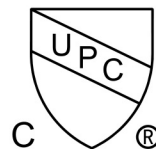

STANDARDS

- Third party certified to meet ASME A112.18.1 all applicable requirements referenced therein

Important

IMPORTANT

1. Please check that all components are present.
2. Before installation ensure that all feed lines are clear of debris and on/off valve is present.
3. Ensure water pressure is between 20-125 PSI (includes combination of hot and cold feed lines).
4. Pictures in the manual are general in content and may not represent exactly your purchased faucet. If you are having difficulties please contact a professional plumber.
5. If you will be away from home for an extended period you should shut off the main water supply.
6. Please insure that to make a wash for all water pipe before installation to insure no impurity inside.
7. When you need to welding the shower valve to the water pipe of the valve, please remember to take out the cartridge and any seal parts of the valve. When finish welding, need to wait for body of the valve cool down and then install the cartridge and the seal parts.
8. Need to used the 11-13N.m power to lock the cartridge.



All valve have the pass the the air testing and pressure testing before ship out. If request presssure testing before installation, Must under the guide of the professional Plumber with license. And air pressure do not over 125PSI. If you want to the Brust testing over 500PSI, you need to changed a new cartridge for normal using.

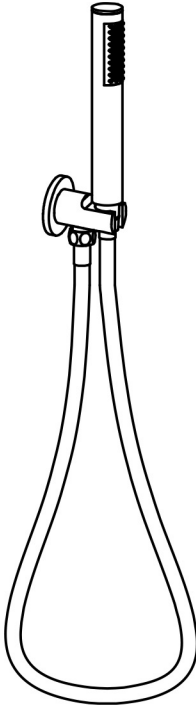
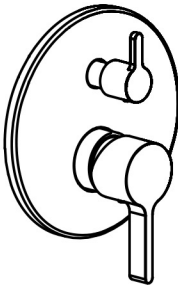
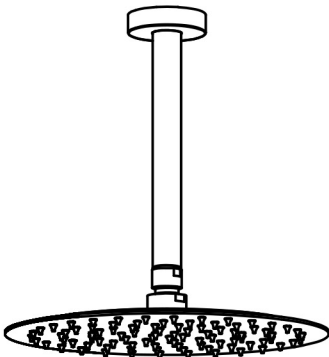

Technical drawing

RECOMMENDED TOOLS

Adjustable wrench Philips Screwdriver
Pipe tape Hexagon wrench

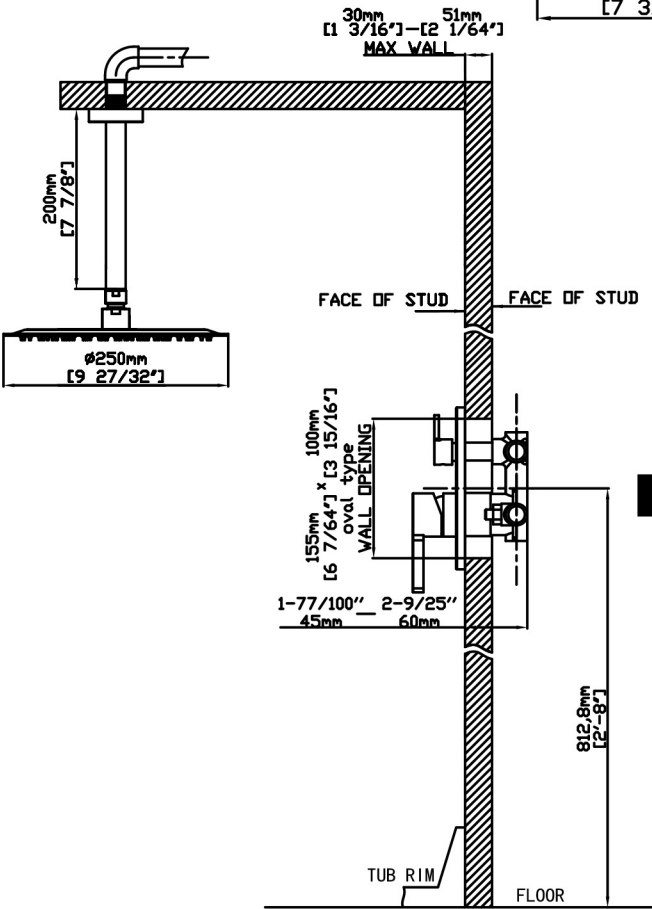
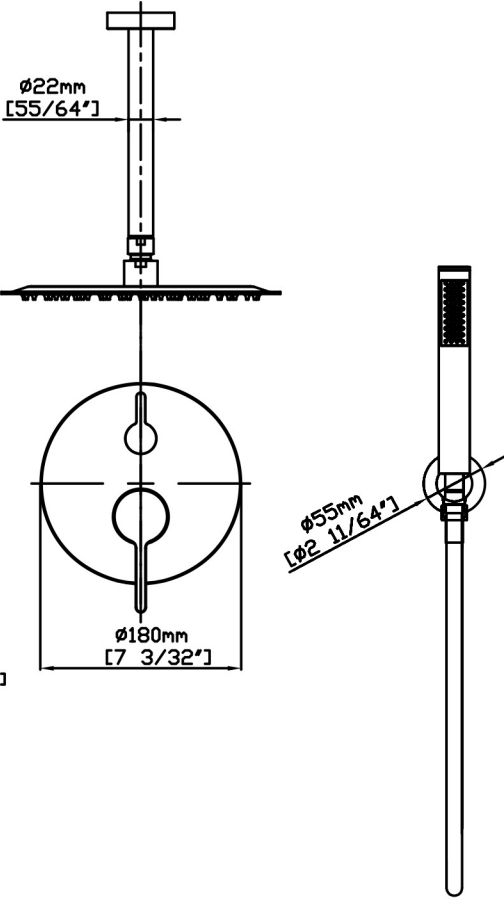

Before you begin

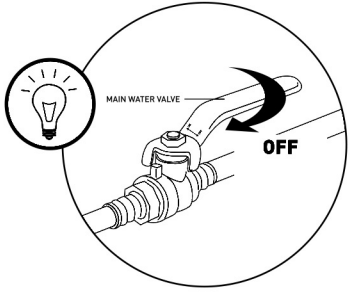

Note: Dimensions are for reference only.
Detailed information is in accordance with the final product.

Installation steps

1

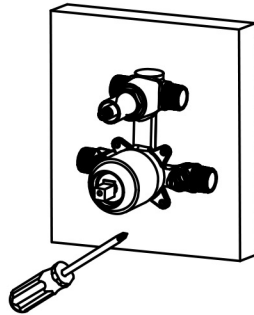

1. Align and securely screw the pressure valve onto the wooden block.

2

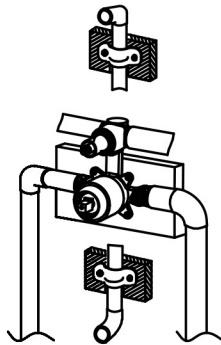

2. Connect the hot & cold inlet & outlet pipes to the pressure valve.

3

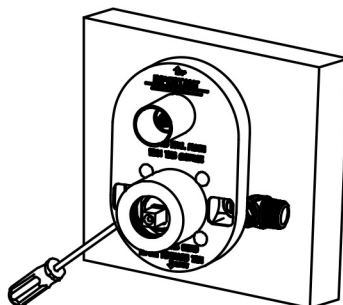

3. Screw in the oval protective cover over the pressure valve and pipes.

Installation steps

4

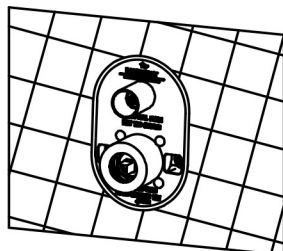

4. Cut the bathroom tile wall according to the size and shape of the protective cover (about 5mm bigger than the protective cover from each side). Please put the tile outside the wooden block.

5

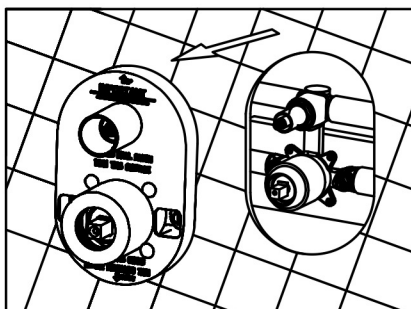

5. Loosen the screw and remove protect cover.

6

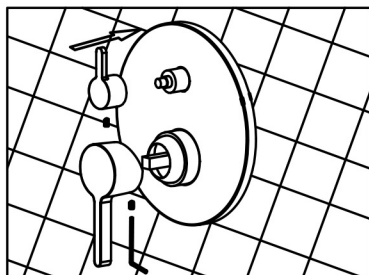

6. Lock the face plate into the body and cling to the wall. Put on the handle then tighten the screw.

Installation steps

7

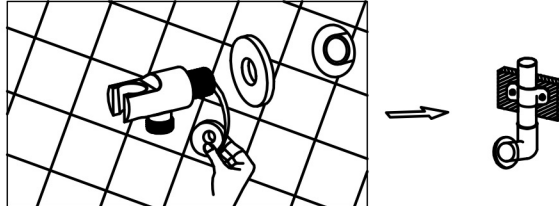

7. Wrap the thread of spout with teflon tape (ensure it must wrap clockwise). Screw-in to the inlet pipe inside the wall, then install the decorative cover on the wall fitting.

8

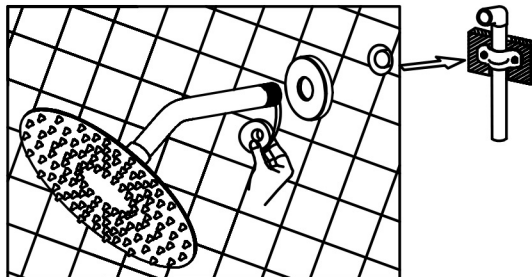

8. Install the shower arm, shower head, and flange to the fitting to the wall. Affix the shower head to the shower arm with the thread seal tape. (tape in the clockwise direction).



THE ANSWER TO IDEAL LIVING



Call us (9-8 EST): +1 888-257-3857

Email us (24/5) : service@casainc.com

Message us : +1 562-551-8092

For sales : dtc@casainc.com