

DUAL SHOWER HEADS SET

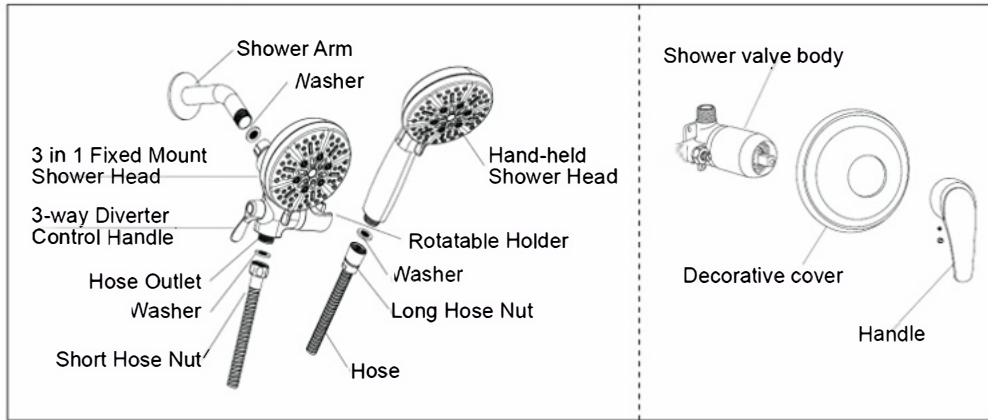

INSTRUCTION MANUAL

- Gather the tools to install the shower head.



Adjustable Wrench (not included)

- Remove old shower head and remove all pipe tape as well.
- Insure that the washer from the old shower is not connected to the pipe. Use a thin utensil to check inside the pipe for washers, such as a pencil or screw driver. Do not use your fingers.

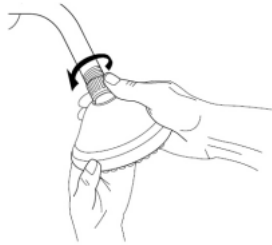

WARNINGS:

- To avoid hot water dangers and conserve even more energy, make sure your water heater is set at 120°F (48.9°C) or below.
- As with all combination showers, using both shower together always cause water pressure to drop in each shower head. Use shower head or hand shower individually to maximize water pressure for high-power performance. Use combined dual-shower application for gentle pampering, wide flow coverage and targeting of different body areas.
- Always ensure the hand-held shower head is properly placed in the bracket, so as to prevent the shower head from falling.
- Do not pull on or tug the flexible hose. This may result in the shower head coming loose and falling.

INSTALLATION INSTRUCTIONS

Note: Several U.S. state and local municipal plumbing codes require the use of a backflow prevention device when installing a hand shower. This device is termed a vacuum breaker. If your hand shower includes a vacuum breaker it will be located in the plug of hand-held shower.

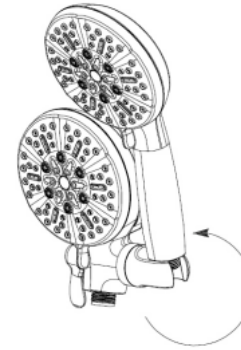

To Adjust Angle of Hand Shower
Rotate holder in vertical direction to set desired hand shower angle.

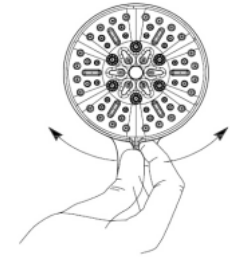

Spray Selector

Spray Selector allows you to select from various spray patterns. Spray pattern is controlled by the small lever that rotates left and right.



To Save Water while Lathering or Shampooing

To save water, turn dial lever to pause mode. For your safety (to prevent pressure buildup), pause mode has water dripping instead of complete shut-off. After use, do not leave dial set to pause mode.

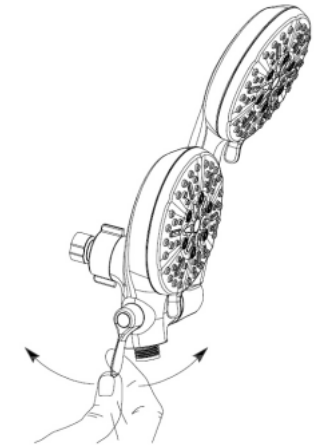

To Use 3-way Diverter

To change between the hand-held or fixed mount spray or combination of both, turn the handle on the 3 in 1 fixed mount shower head clockwise or counter clockwise.

INSTALLATION INSTRUCTIONS

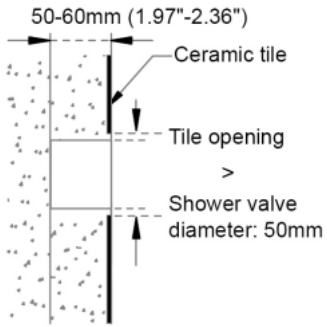
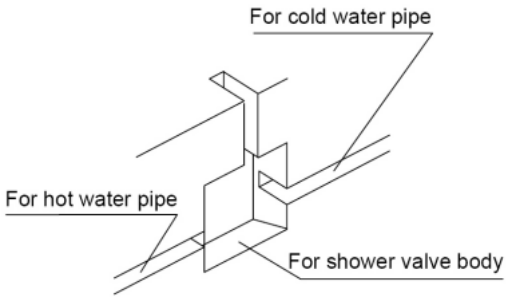

1) Use special tools to chisel holes on wall for installing, shower valve body and water pipe.

2) Recommended depth for installing shower valve body before tiling tiles: 50-60mm (1.97"-2.36"). Note: Tile opening should be bigger than shower valve diameter at least 5 mm.

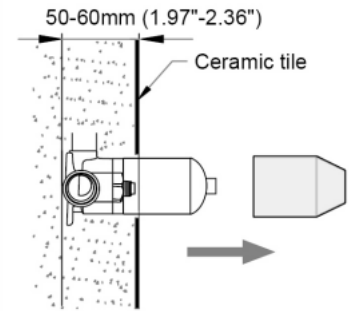
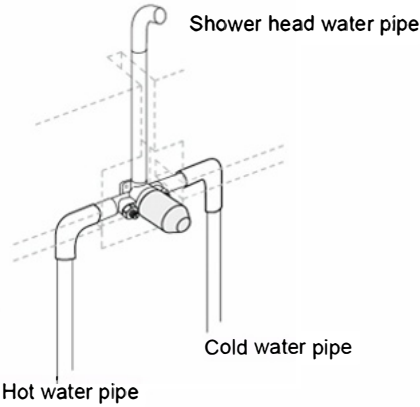

3) Connect water pipes to shower valve body as picture shows. And then install the shower valve body with screws.

4) Switch on/off the cartridge, check all connectors without any leakage. And then seal the wall and take off protection cover.

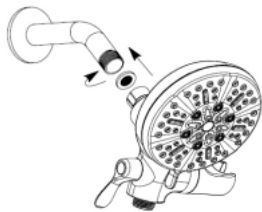
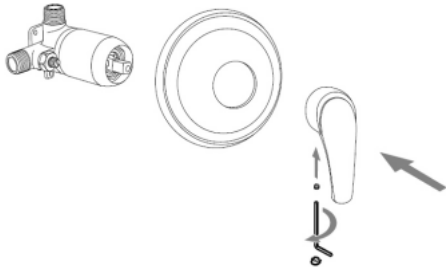

5) Put decorative cover on the shower valve, and tighten the handle as picture shows.

6) Attach 3 in 1 fixed mount shower head by threading clockwise onto shower arm with rotatable holder to the right and 3-way diverter control handle to the left. Use a wrench to tighten shower head nut to a snug fit. Do not over tighten. Wrap shower head nut with a cloth if you are using pliers.

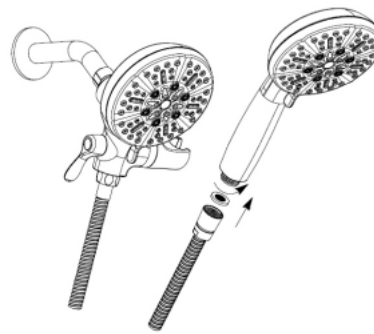

7) Locate the hose end with short hose nut and hand tighten to shower head. IMPORTANT! If hose is not installed in this manner unit will not operate properly.

8) Place hand-held shower head in rotatable holder. Point all shower heads away from you and turn on the water full force. Check for leaks. Re-tighten all connectors if necessary.

