

INSTALLATION INSTRUCTIONS

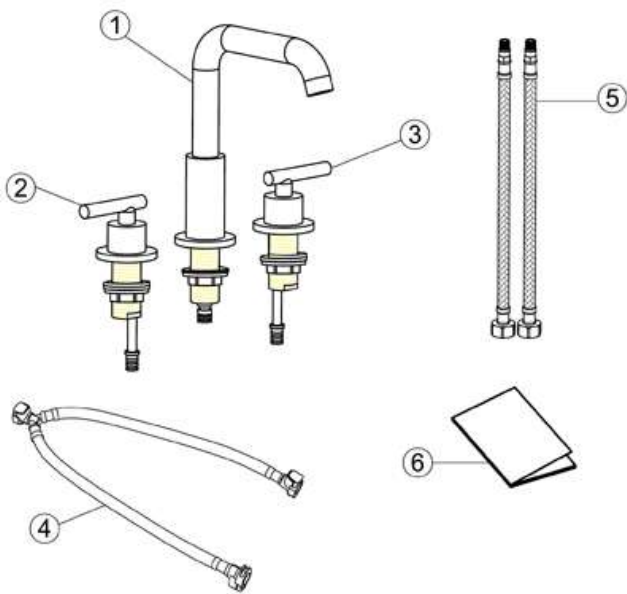

Parts list

NO	PART NAME	QTY	NO	PART NAME	QTY
①	Faucet	1	④	Quick Connector Hose	1
②	Hot Water Knob Parts	1	⑤	Water Supply Hose	2
③	Cold Water Knob Parts	1	⑥	Instructions	1

Three faucet styles

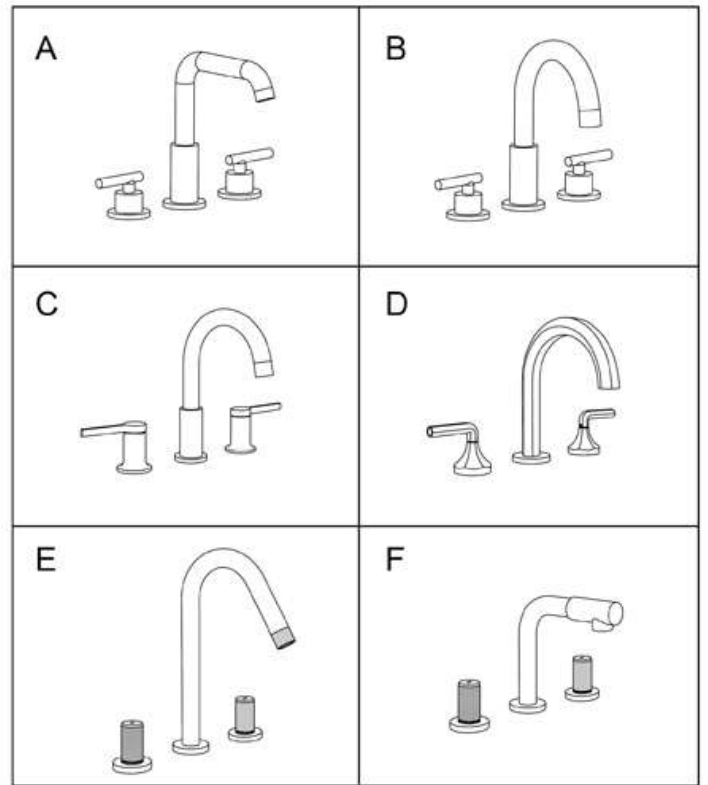

INSTALLATION INSTRUCTIONS

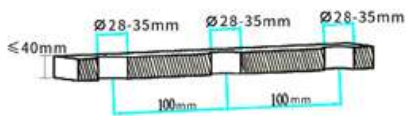

1. Slotting three holes in your bathroom sink (the holes' distances as shown in the photo 1)

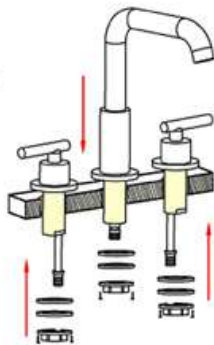

2. Place the faucet body and handles into sink holes, screw the plastic washer, metal washer and locking nut to the thread pipe of the faucet as photo 2

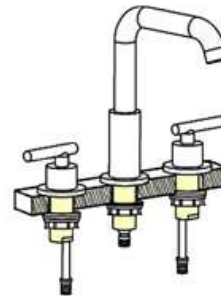

3. Adjust the position of the faucet and the handles then hand tighten the locking nut and then use a screwdriver to tighten the screws on the locking nuts to secure the faucet

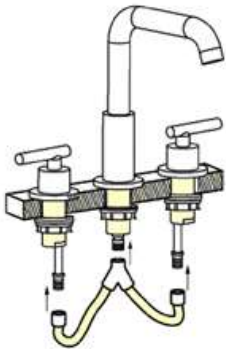

4. Push the blue button on the quick connect hose and insert the hose to the faucet and the handles' pipe as photo 4

Check and make sure the quick connect hose is well connected

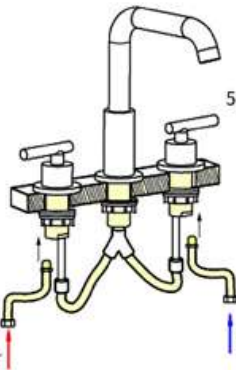

5. Screw the water supply lines to the faucet body, the handles and the stop valves

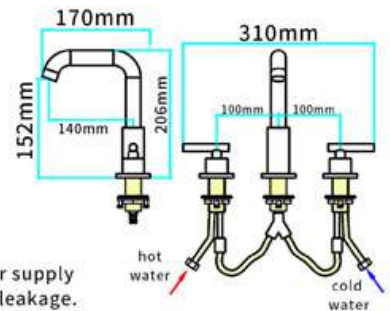

6. Turn on water supply to check for leakage. Then let the water run for 30 seconds